

DOCUMENT RESUME

ED 249 048

SE 044 893

AUTHOR Williams, Debbie; Hickson, Carol
TITLE Demonstration Aids for Aviation Education. [Volume II].
INSTITUTION Federal Aviation Administration (DOT), Washington, D.C.
REPORT NO GA-20-30-B
PUB DATE [84]
NOTE 111p.; For 1970 publication, see ED 065 293.
PUB TYPE Guides - Classroom Use - Guides (For Teachers) (052)

EDRS PRICE MF01/PC05 Plus Postage.
DESCRIPTORS *Aerospace Education; Air Pollution; Communication (Thought Transfer); *Communications; Elementary School Science; Intermediate Grades; *Learning Activities; Noise (Sound); Physical Environment; Physical Sciences; *Science Activities; Science Experiments; *Space Exploration
IDENTIFIERS *Aviation Education

ABSTRACT

This series consists of four packets containing simple, concrete activities for students in the upper elementary grades. The purpose of the series is to illustrate certain principles related to various concepts of aviation and space. Each packet forms a coherent program of instruction on a single topic: (1) non-powered flight; (2) aerospace and the environment; (3) space exploration; and (4) aerospace communications. Most of the activity tasks are introduced with questions. Students then follow the activity instructions to find a solution to each question. This kind of student involvement may then lead to other related questions generated by the teacher, other students, or those suggested on the activity cards. Most activities utilize materials readily available from any given community and can be completed in the classroom. Others may require equipment from a science resource center or a local junior/senior high school. All activities can be adapted to meet the needs of varied teaching situations and different grade levels. (JN)

 * Reproductions supplied by EDRS are the best that can be made *
 * from the original document. *



U.S. Department
of Transportation
**Federal Aviation
Administration**

Demonstration Aids for Aviation Education

U.S. DEPARTMENT OF EDUCATION
NATIONAL INSTITUTE OF EDUCATION
EDUCATIONAL RESOURCES INFORMATION
CENTER (ERIC)

* This document has been reproduced as
received from the person or organization
originating it.
Minor changes have been made to improve
reproduction quality.

• Points of view or opinions stated in this docu-
ment do not necessarily represent official NIE
position or policy.

Office of Public Affairs
Aviation Education, APA-5
Washington, D.C. 20591

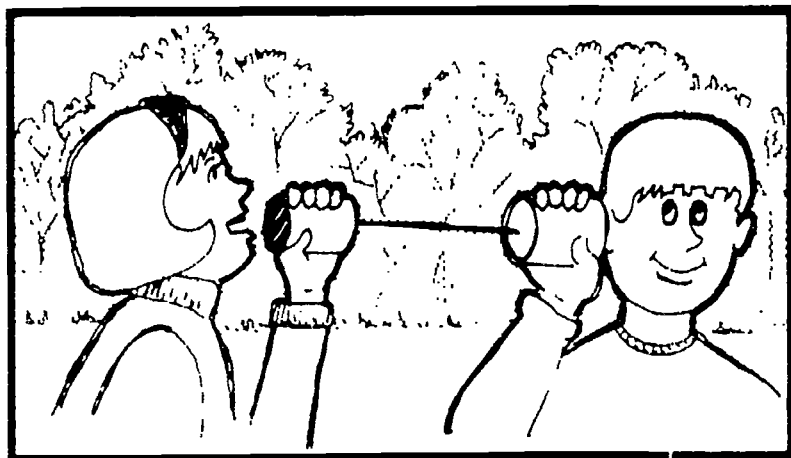

AEROSPACE COMMUNICATIONS

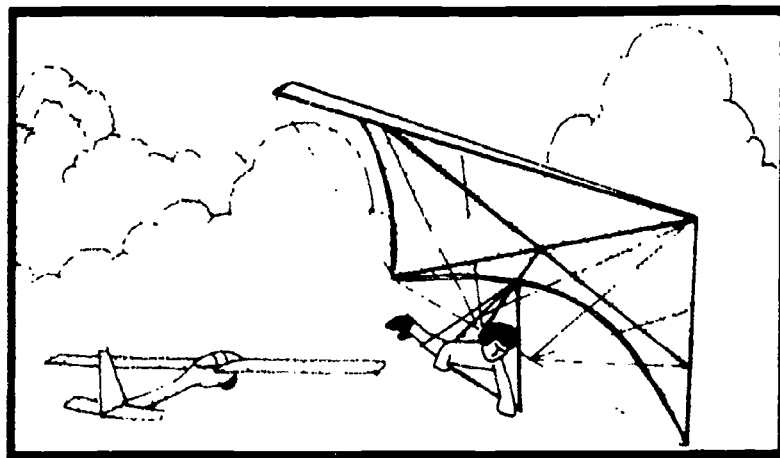

NONPOWERED FLIGHT

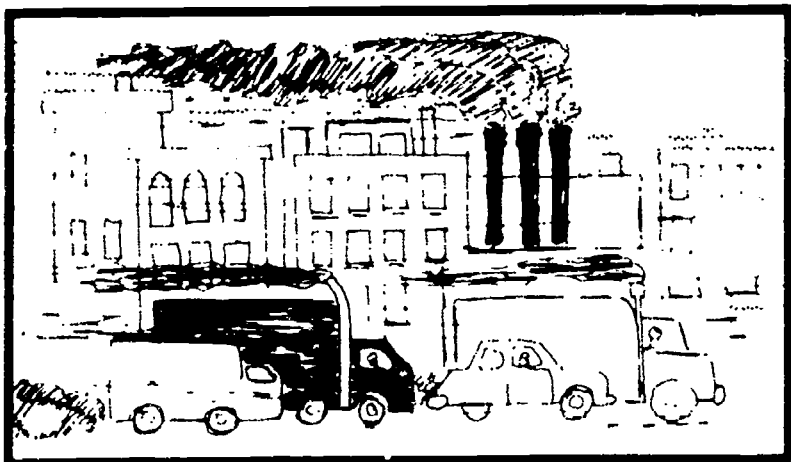

AEROSPACE AND THE ENVIRONMENT

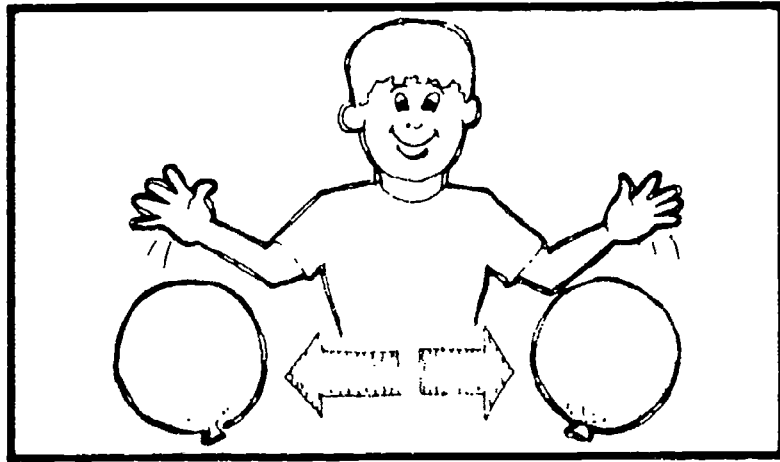

SPACE EXPLORATION

ED249048

SE 04 89 3

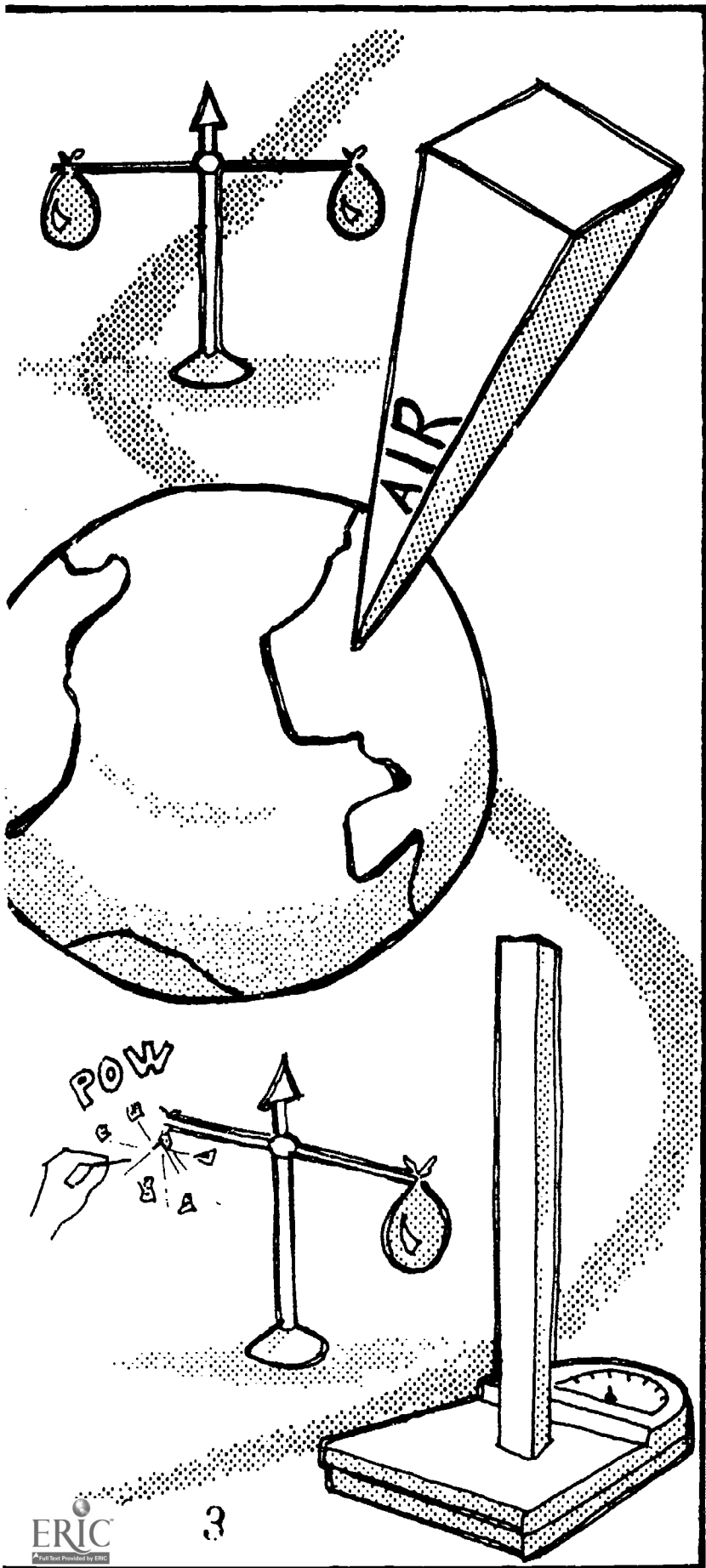

DEPARTMENT OF TRANSPORTATION
FEDERAL AVIATION ADMINISTRATION

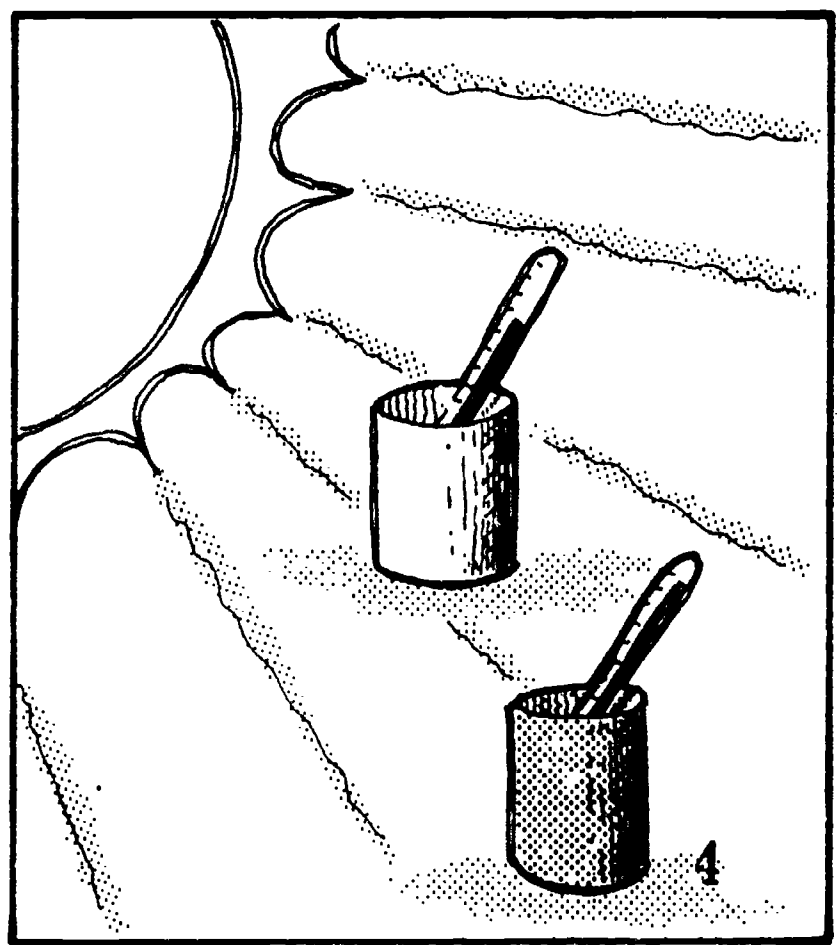
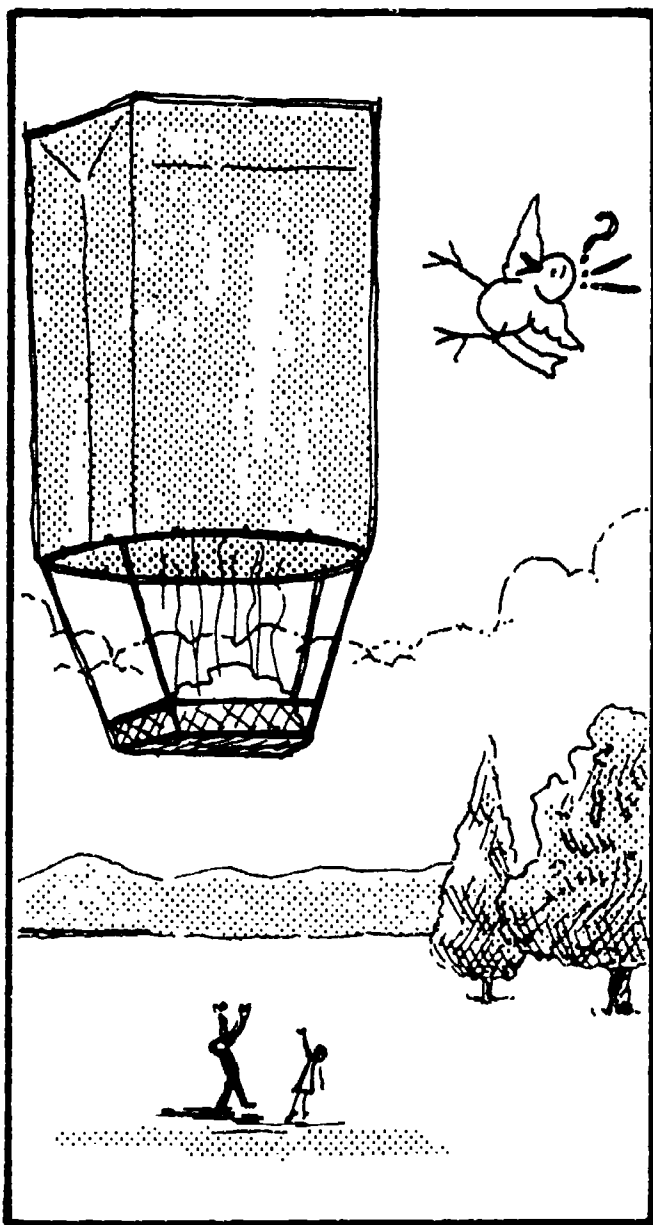
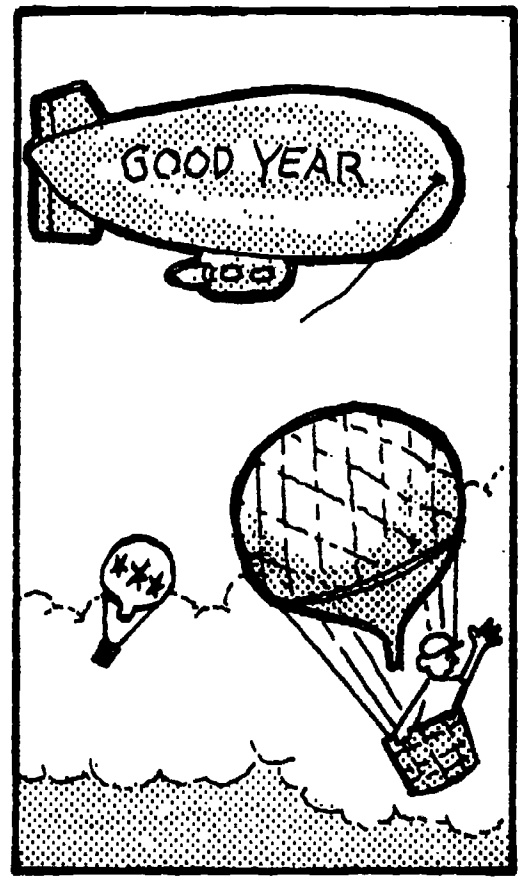



TEACHER'S INFORMATION

Demonstration Aids for Aviation Education—Volume II is a series of simple, concrete, revealing experiments developed by the Civil Air Patrol Center for Aerospace Education Development for the Federal Aviation Administration specifically for upper elementary grades. These activities can be adapted to meet the needs of varied teaching situations and different grade levels.

These materials are primarily designed as pupil directed experiences. In some instances the teacher may want to further extend the investigations. This series is intended to be a springboard for your own ideas to demonstrate concepts of the Air Age to your students. Young children can learn scientific principles through simple learning activities; older students can benefit from a review using the same activities.

The purpose of this series is to illustrate certain principles related to various concepts of aviation and space. More important, it is an opportunity for you to directly involve students in investigations and in making discoveries on their own.

You needn't be an "expert" in science to use this material. In fact, you shouldn't be expected to have all the correct answers to the questions presented in the material. Moreover, many of the activities are designed to include interdisciplinary skills and need not be used in sequence.

Each packet in the series forms a coherent program of instruction on a single topic: Non-powered Flight, Aerospace and the Environment, Space Exploration and Communications. Most of the tasks are introduced as a question. In order to answer the question, the students may want to first predict the solution. Then have them follow the activity instructions to arrive at an answer. This kind of student involvement may lead to other related questions generated by the teacher, other students, or suggested on the cards themselves.

Most of the activities utilize materials readily available from any given community and can be completed in the classroom. Others may require that you borrow some equipment from your science resource center or from a junior or senior high school in your district.

Please let us know your reactions to the materials and feel free to ask for more information related to aviation or space. We wish you success and many enjoyable experiences as you use these packets.

Written by Ms Debbie Williams and Ms Carol Hickson
Editorial Assistance by Mrs. Patricia Smithson
Illustrated by Mr. Harley A. Samford

The air envelope around the earth extends about 500 miles above us. It is made of very tiny molecules barely measurable. One column of air, one square inch from earth to outer space weighs about 15 pounds.

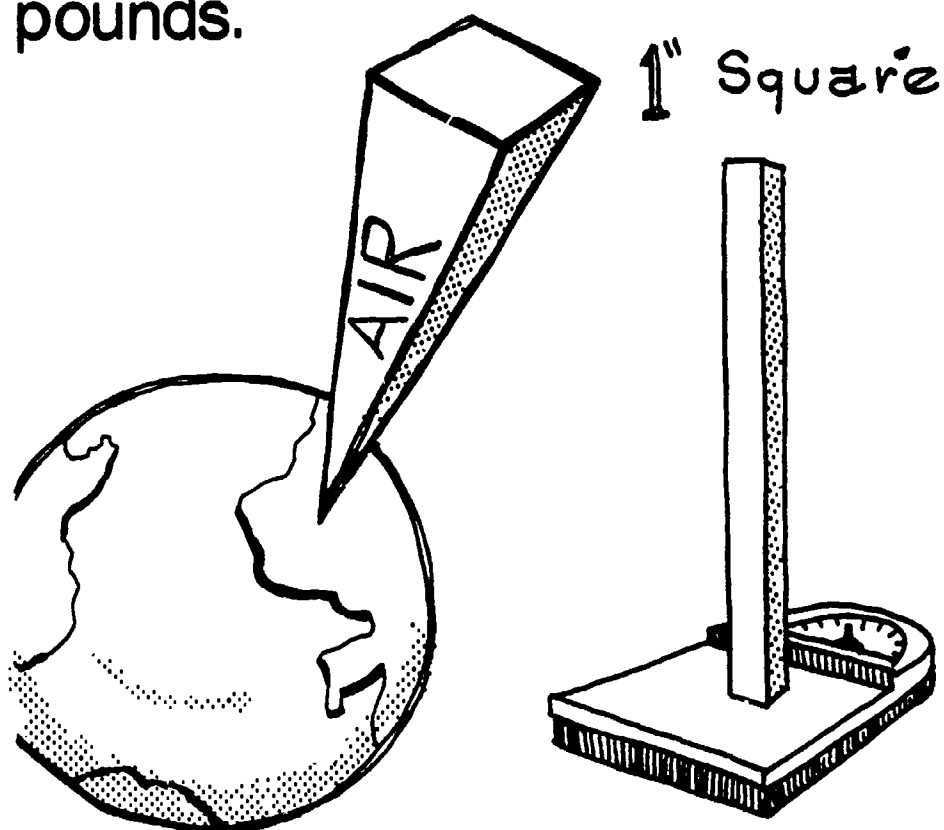

MATERIALS:
Balance
2 inflated balloons
Pin

Balance two inflated balloons on the scale. Pop one

of them with a pin.

When the air leaves the broken balloon, it weighs less and rises.

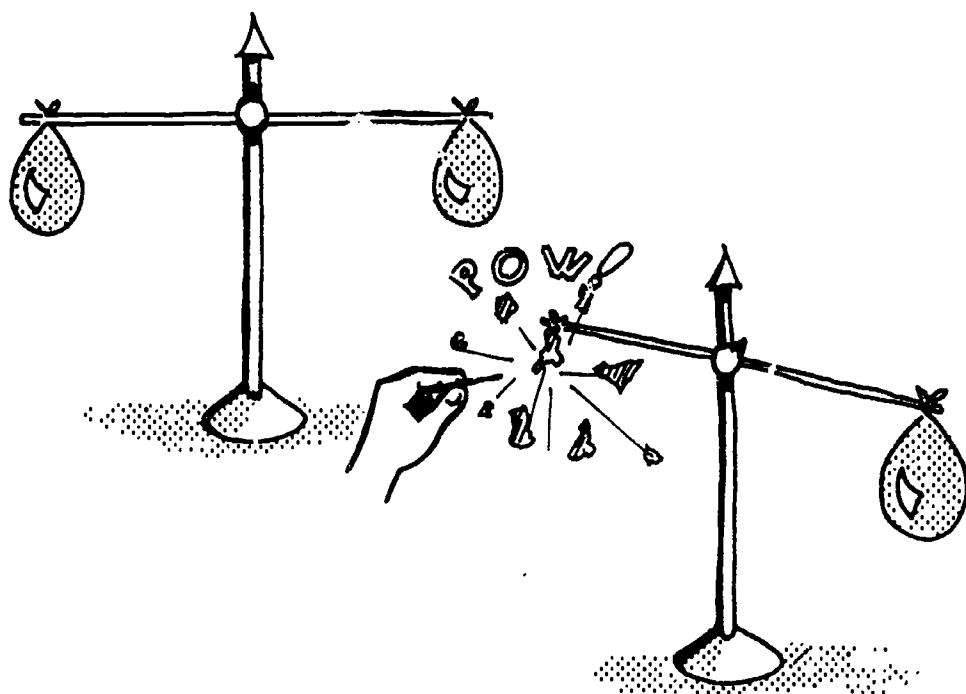

WHICH IS HEAVIER, AN INFLATED BASKETBALL OR A DEFLATED ONE?

LA-2

MATERIALS:
Basketball (inflated)
Scale Weights

Weigh an inflated basketball. Record the weight.
Remove the air from the ball. Weigh it again.
Compare the weights.

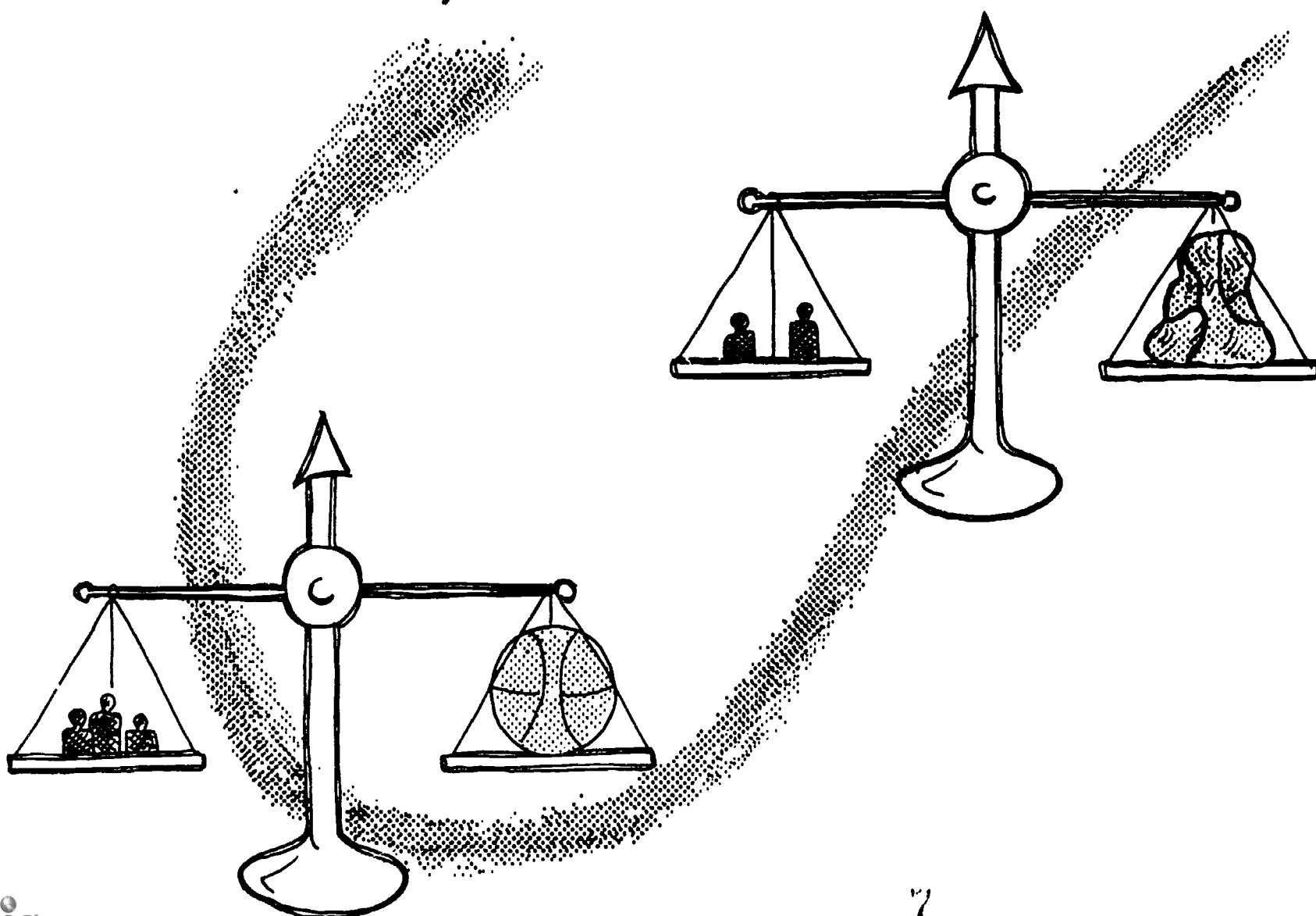

Blimps, balloons, and other lighter-than-air craft fly because they are lighter than air surrounding them. They float upward like a hollow ball floats to the top of water.

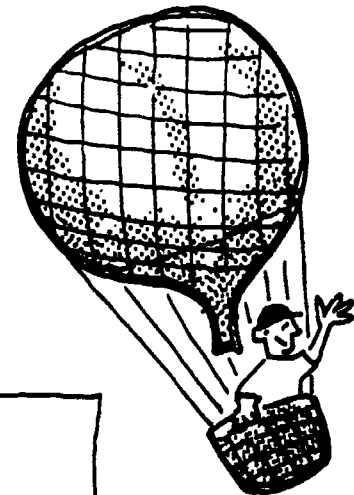
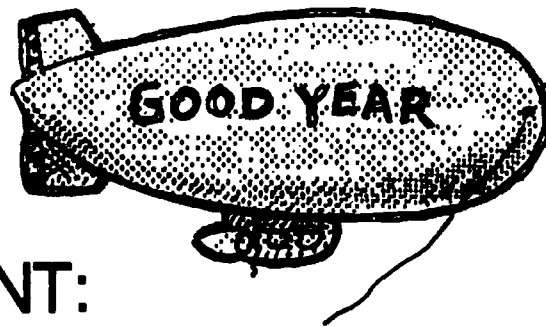

EXPERIMENT:

MATERIALS:

Balance Cooking oil
Water
2 Containers of equal weight

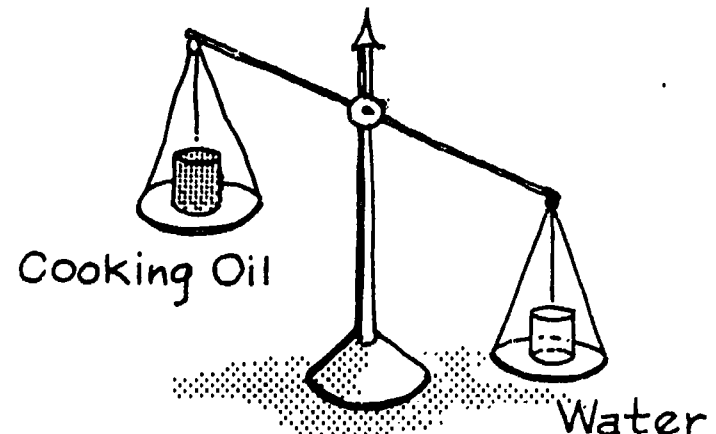
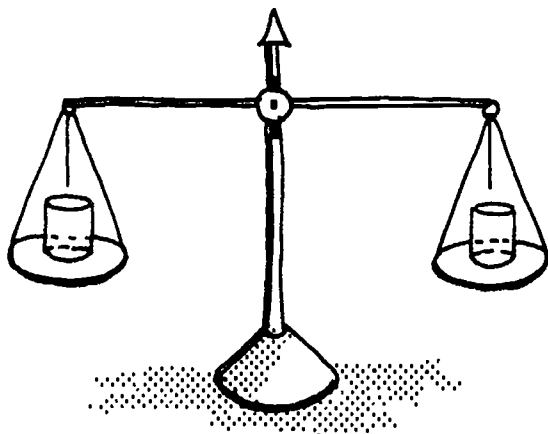

Balance the two containers on the scale. Add equal amounts of water and cooking oil to each container. The amount is not important. One drop of water will always be heavier than one drop of cooking oil because water is heavier than cooking oil.

Now that we have established that water weighs more than cooking oil, let's try something else. What happens if we mix the two?

MATERIALS:

Jar & lid Cooking oil
Water Food coloring

Fill the jar half way with cooking oil. Add colored water until it is

to the top. What happens? Now put the lid on the jar and shake it for about 10 seconds. Let it stand for several minutes. What is happening?

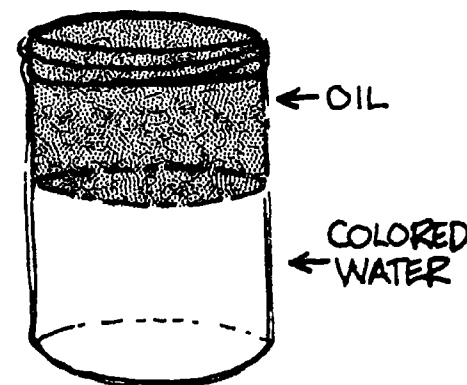

Look at it again in 30 minutes. Why is it back to its original condition?

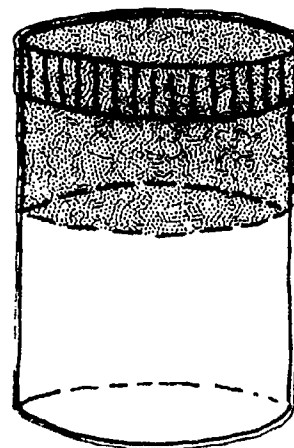
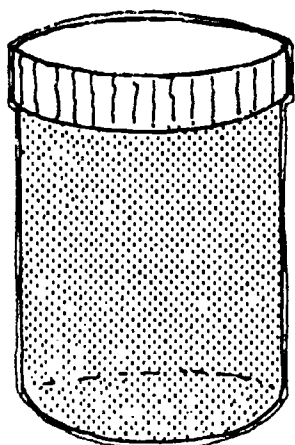

Oil is pushed upward because it is lighter than water. Air will push a lighter substance upward in a similar way. Hot air is one of these lighter substances.

IT'S FULL OF HOT AIR!

LA-5

This activity should be done only with the supervision of the teacher or other designated adult.

Hot air is light because the molecules of air move faster when heated. Water molecules also move faster when heated. You can see the results of heated water as you watch it boil. As air molecules “boil” or move rapidly, they spread out and are fewer in a given area.

MATERIALS:

Hot plate Balloon
Pop bottle Water
Sauce pan

Put some water in a sauce pan and place it on the hot plate. Put the balloon over the top of the pop bottle and place the bottle in the water. Heat the water. As the air molecules in the

bottle warm, they begin to spread out and fill the balloon. There are fewer air molecules left in the bottle so air in the bottle weighs less than it did before it was heated.

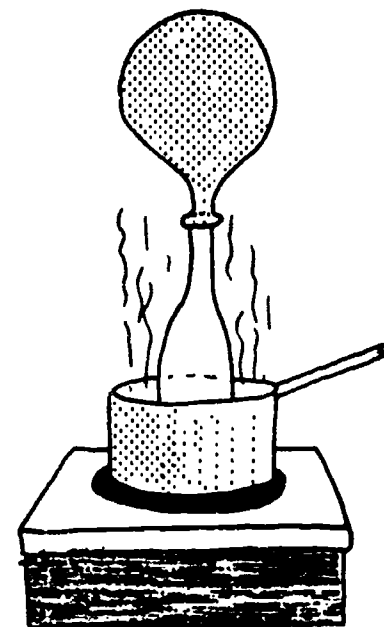
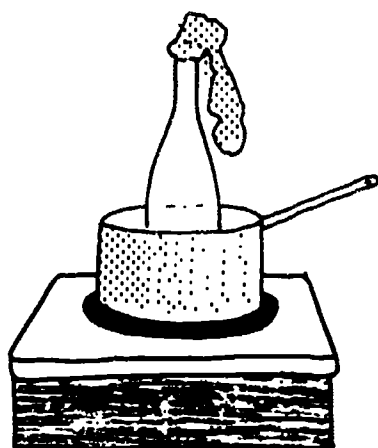

WHAT HAPPENS WHEN AIR IS HEATED?

LA-6

This activity should be done only with the supervision of the teacher or other designated adult.

MATERIALS:
Four sided can
Water
Heat source

Put a small amount of water in a can. Heat the water until it boils and steam from the boiling water drives the air out of the can. Allow the water to boil for a few minutes.

Remove the heat source and screw the lid on the can tightly.

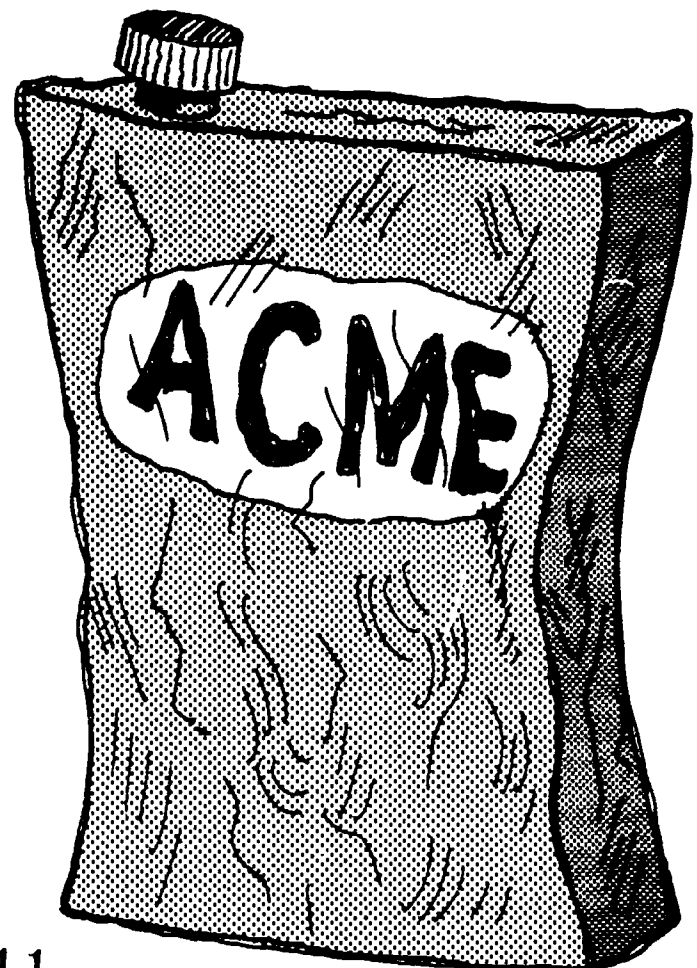
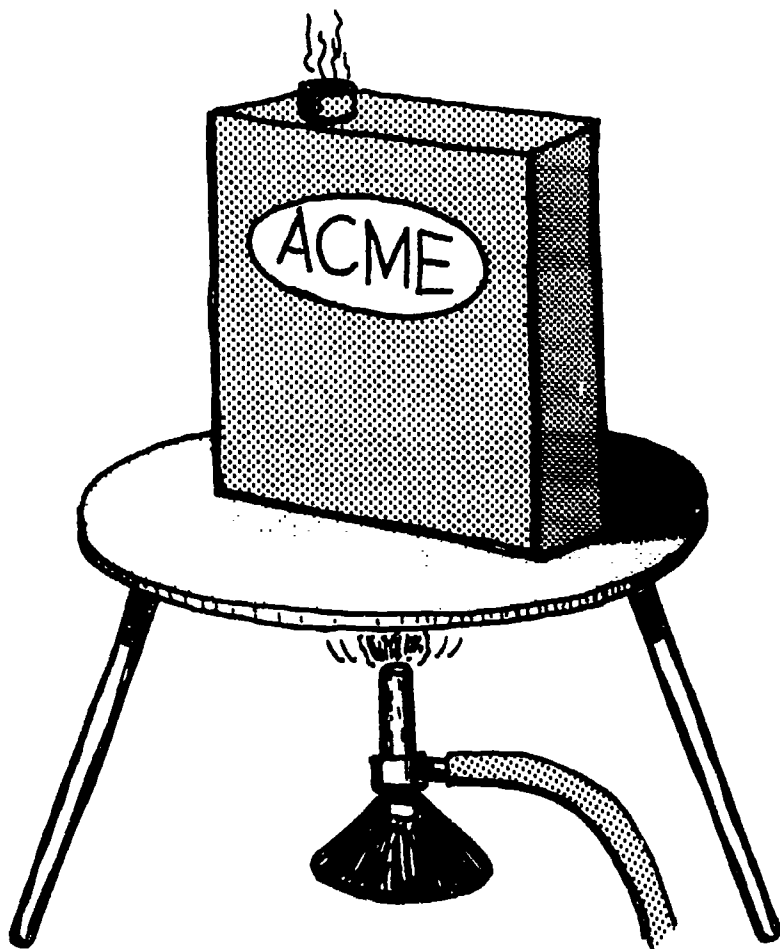

Watch the can . . .

Why does this happen?

WHERE DOES HOT AIR GO?

This activity should be done only with the supervision of the teacher or other designated adult.

Because hot air is lighter, it is pushed upward by cooler, heavier air. (Remember the oil and water?)

MATERIALS:

Balance Candle
Aluminum foil
Washer (or other light weight)

Make a large hollow shape out of aluminum foil. Attach it to one arm of the scale. Attach enough weight to the other arm to balance the scale. Hold a candle under the foil.

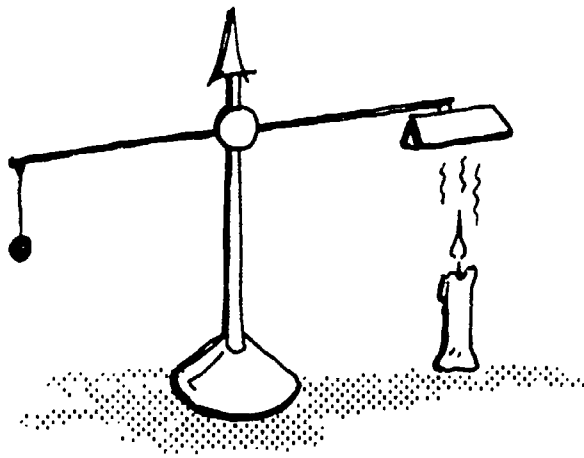
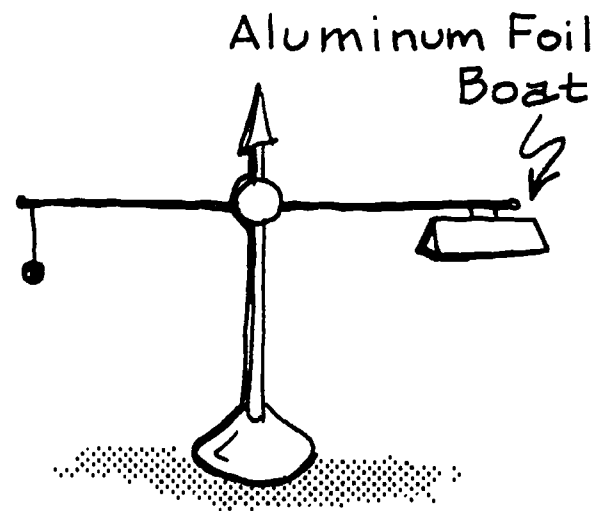

As the flame heats the air, it becomes lighter and surrounding air will push the hot air and foil upward. Other gases that are lighter than air are hydrogen and helium.

You can make a hot-air balloon with a controlled heat source.

MATERIALS:

A light paper bag
Cotton balls
Alcohol
Wire Matches

This activity should be done only with supervision of the teacher or other designated adult.

Try a simple paper bag balloon. First, make a simple basket and ring from lightweight wire. Attach the ring to the mouth of the bag. Place the cotton dampened with alcohol in the basket.

Take the paper bag balloon outside because it may catch on fire. Light the cotton and let your hot-air balloon fly.

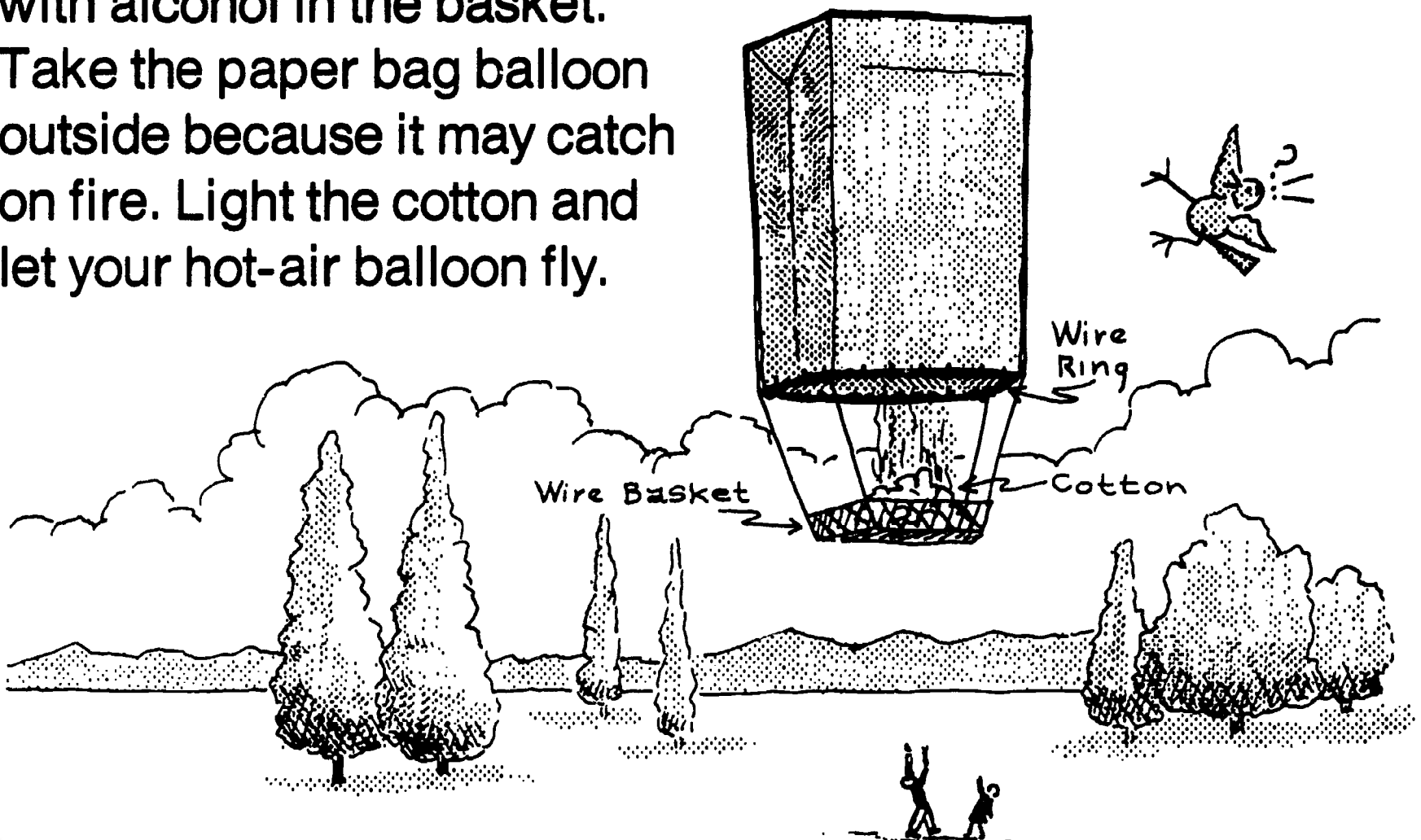

Now let's really get serious about this hot-air balloon business. Let's build a model with a better shape and much better lifting power. In fact you will probably need to attach a kite string so this one will not drift away.

Cut the 6 sheets of tissue paper in the shape of the pattern shown. Overlap the sides of the six sheets of paper and secure with rubber cement. Cut and glue a circular piece of tissue paper to the top.

Make a wire ring and basket and attach to the mouth of the balloon.

Take your balloon outside, dampen the cotton with alcohol, carefully light it and let it go (remember to tie a string to it if you don't want to lose it).

(This activity should be done only with supervision of the teacher or other designated adult.)

MATERIALS:

6 sheets of thin tissue paper
Rubber cement
Wire Matches
Cotton
Alcohol

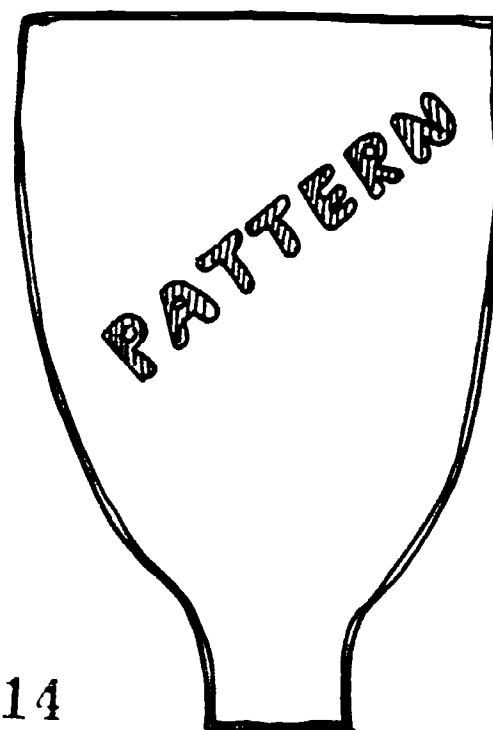

Why does the balloon
rise in the air?

What guides the balloon?

Would the balloon fly
better on a warm or a cold day?

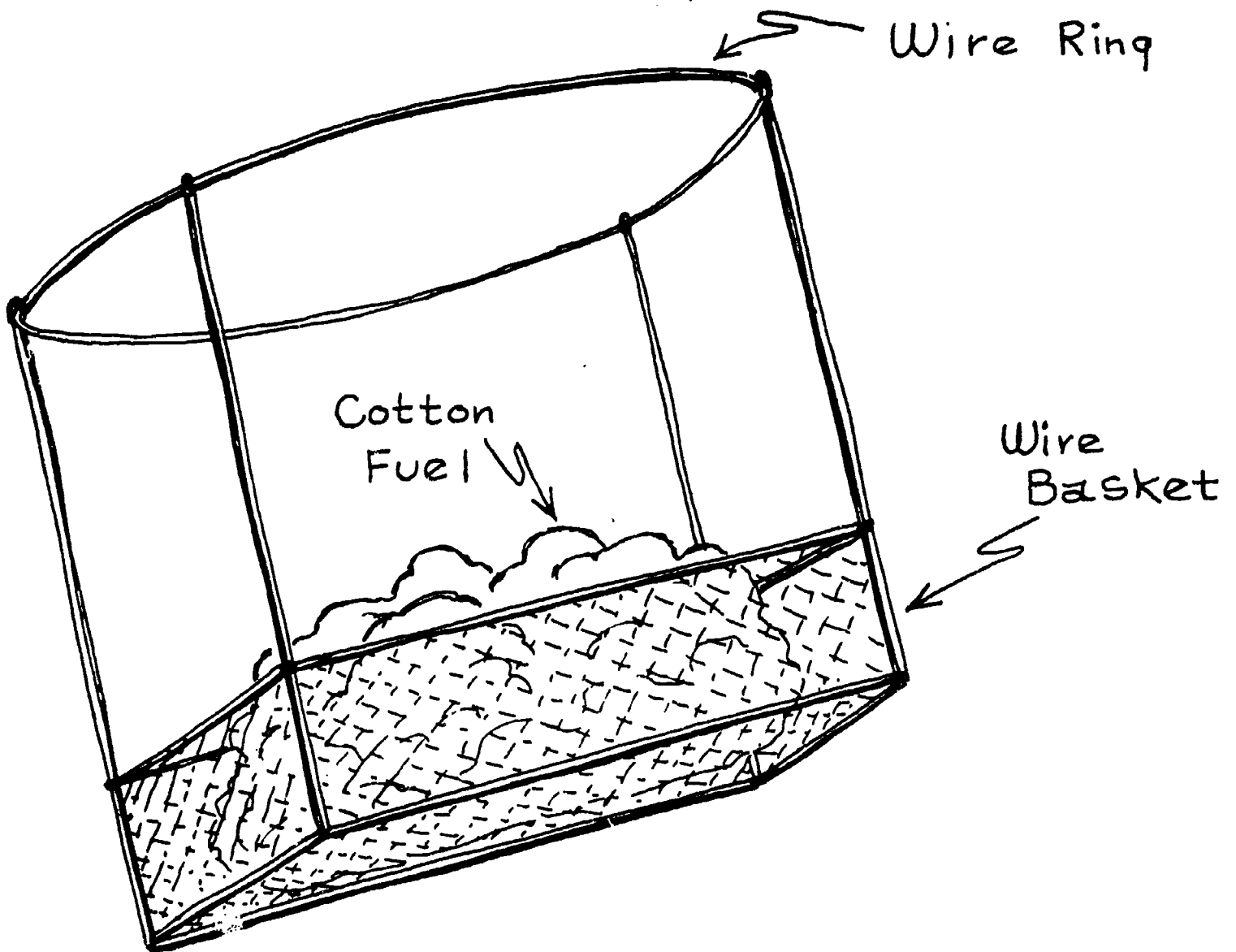
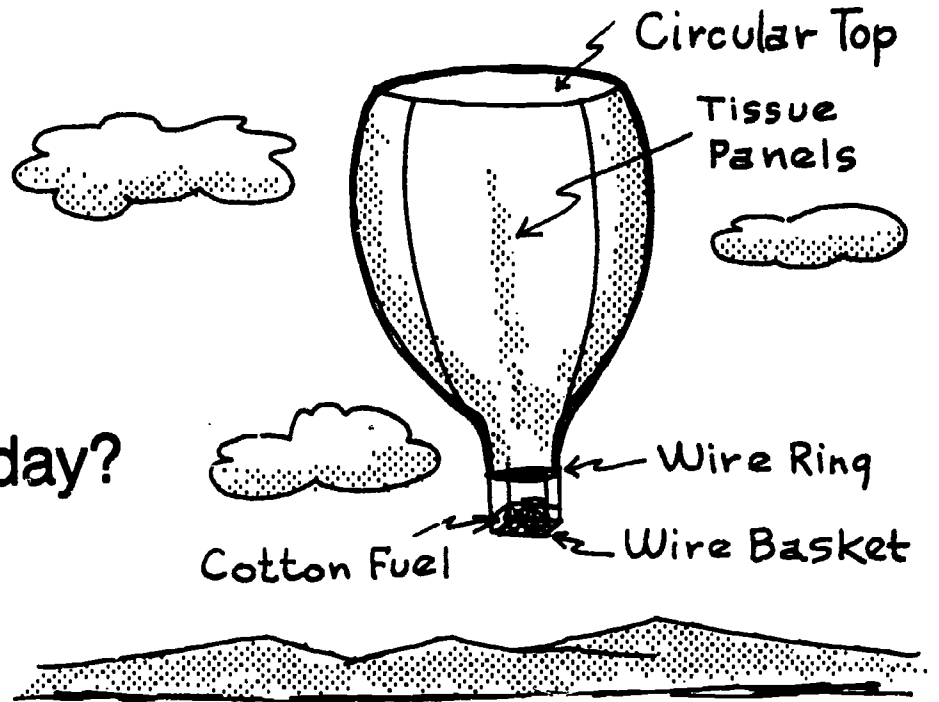



Just as a cork floats on water, warm air floats on top of cold air. This is because the warm air is less dense and lighter than cold air. Can you think of some simple experiments to show that warm air is lighter than cold air?

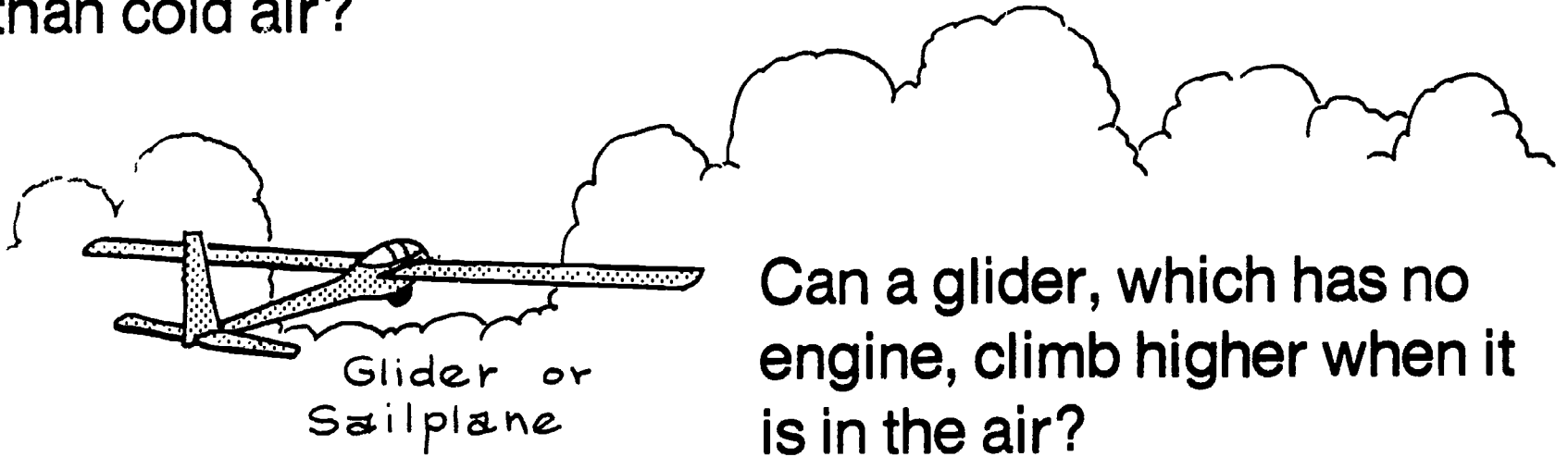

Glider or
Sailplane

Can a glider, which has no engine, climb higher when it is in the air?

Can a person hang-gliding move up and down while in flight?

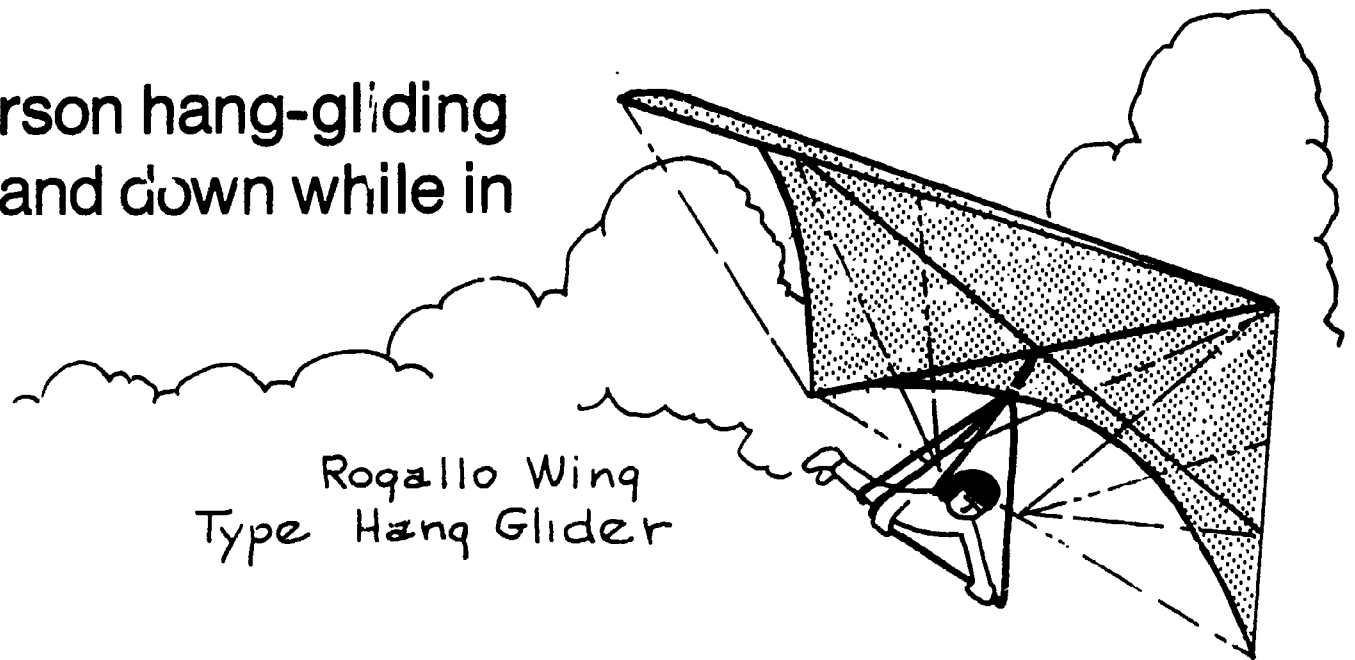

Rogallo Wing
Type Hang Glider

What is a draft? Have you ever felt a cold draft in an old house, or a large theater or restaurant? Why do you usually feel it on your feet?

MATERIALS:

- Pencil with eraser
- Piece of stiff paper
- Thread — Spool
- Scissors — Pin
- Thimble

You can make a swirly-twirly snake toy that moves when it is warmed up. On the stiff paper, draw a spiraling snake. Make your snake large enough that a thimble will pass through

the dark circle at the center (as shown in the drawing). Cut out along the lines. Put the pencil in the spool and the pin in the eraser. Put the thimble through the dark circle at the center of the snake, then put the thimble and the snake on the pin. Hold the toy over a radiator, heater, candle or mantle piece.

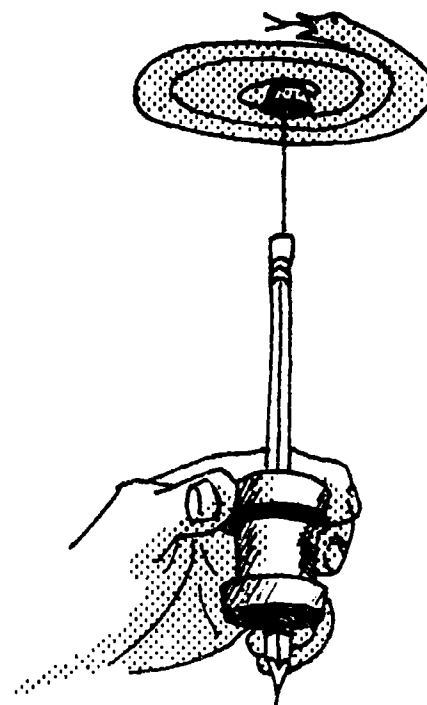
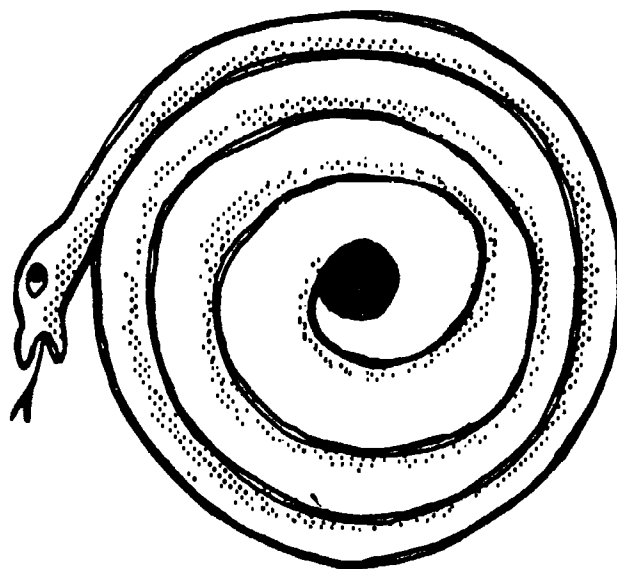

What happens? Why?

Can you use this toy to help explain the movements of the glider and the hang glider?

Try making this soap-bubble balloon.

MATERIALS:

Soap flakes (Ivory, etc.)
Water — Paper disc
Glycerine — Thread
Tissue paper
9" glass tube or straw

Make a stiff lather of soap flakes and water. Add a little glycerine. Make a tissue paper balloonist about 1" high and glue him by a 1 1/2" thread to a paper disc. Take your

materials into a cold room or outside. Dip the tube or straw into the soap solution and blow steadily until a perfect bubble forms. Drop the dry paper disc onto the bubble. As soon as the disc is firmly fixed, carefully turn the tube upward, and the balloon will fly away.

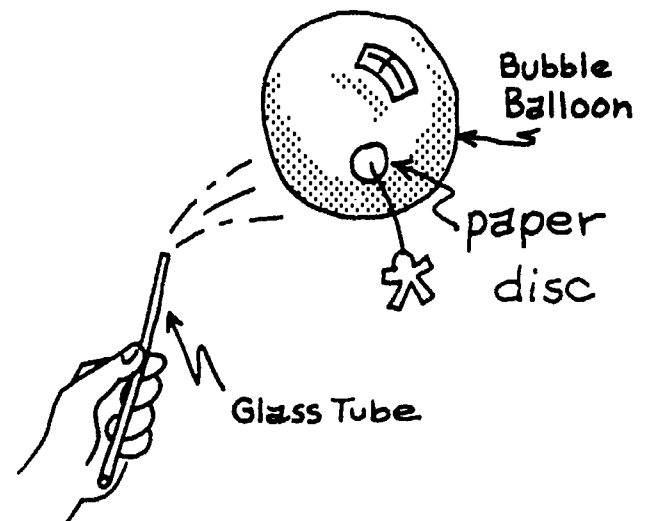

Why is it important to do this experiment in a cold place? How does your breath compare in temperature with your surroundings?

HOW CAN YOU CONTROL TEMPERATURE IN A BALLOON?

LA-12

Some people believe that the higher we go, the warmer it gets because we are closer to the Sun. This is not true. The Sun is 93 million miles away! 100 miles or so closer does not make much difference. Altitude and temperature are not related.

This may help you understand why.

Remove the lid and label from each can. Use carbon from the candle to blacken one of them. Fill both cans with cool water. Place them over a warm radiator, in warm sunlight, or in front of a heat lamp. After 15 minutes measure the temperature of both. The water in the dark can is warmer than the water in the silvery can.

MATERIALS:

2 soup cans
Heat lamp
Thermometer
Candle
Water

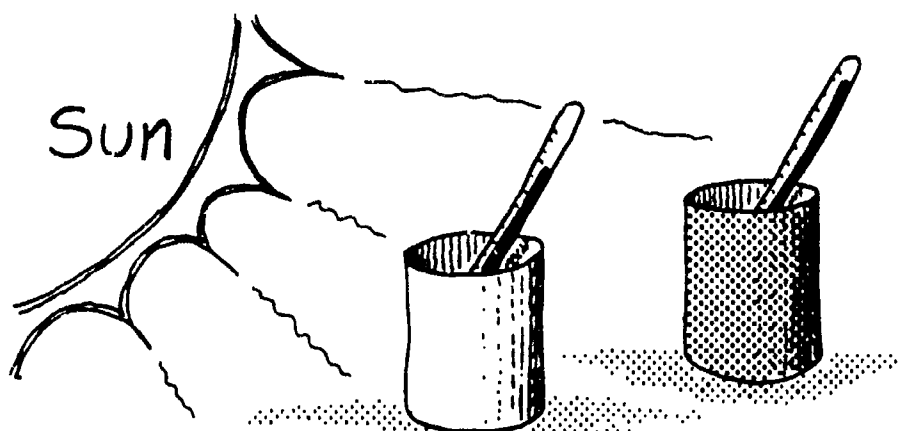

Put the same two cans in a protected place away from air drafts. Fill them both with hot water (not boiling). Measure the temperature 15 minutes later. This time the water in the dark can is cooler than the water in the silvery can.

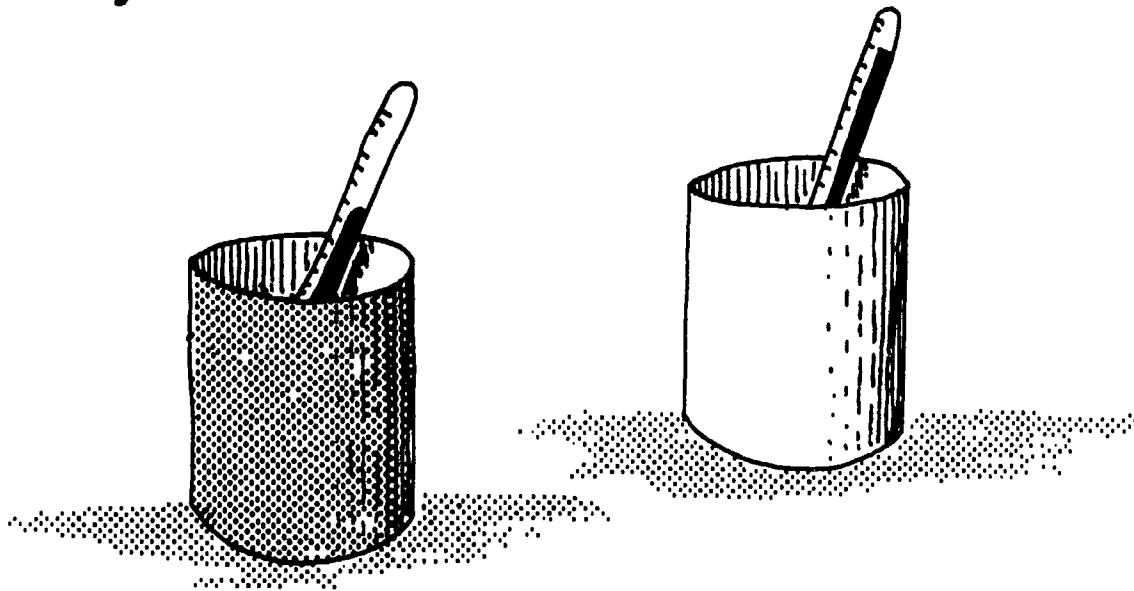

In the first experiment the dark can absorbed more heat than the bright one. In the second experiment the dark can lost more heat than the bright one. So, you can see that material that is a good absorber of heat also loses heat rapidly.

There are many things that can fly, glide and ride the wind because of their special shape and light weight.

Try this paper air foil.

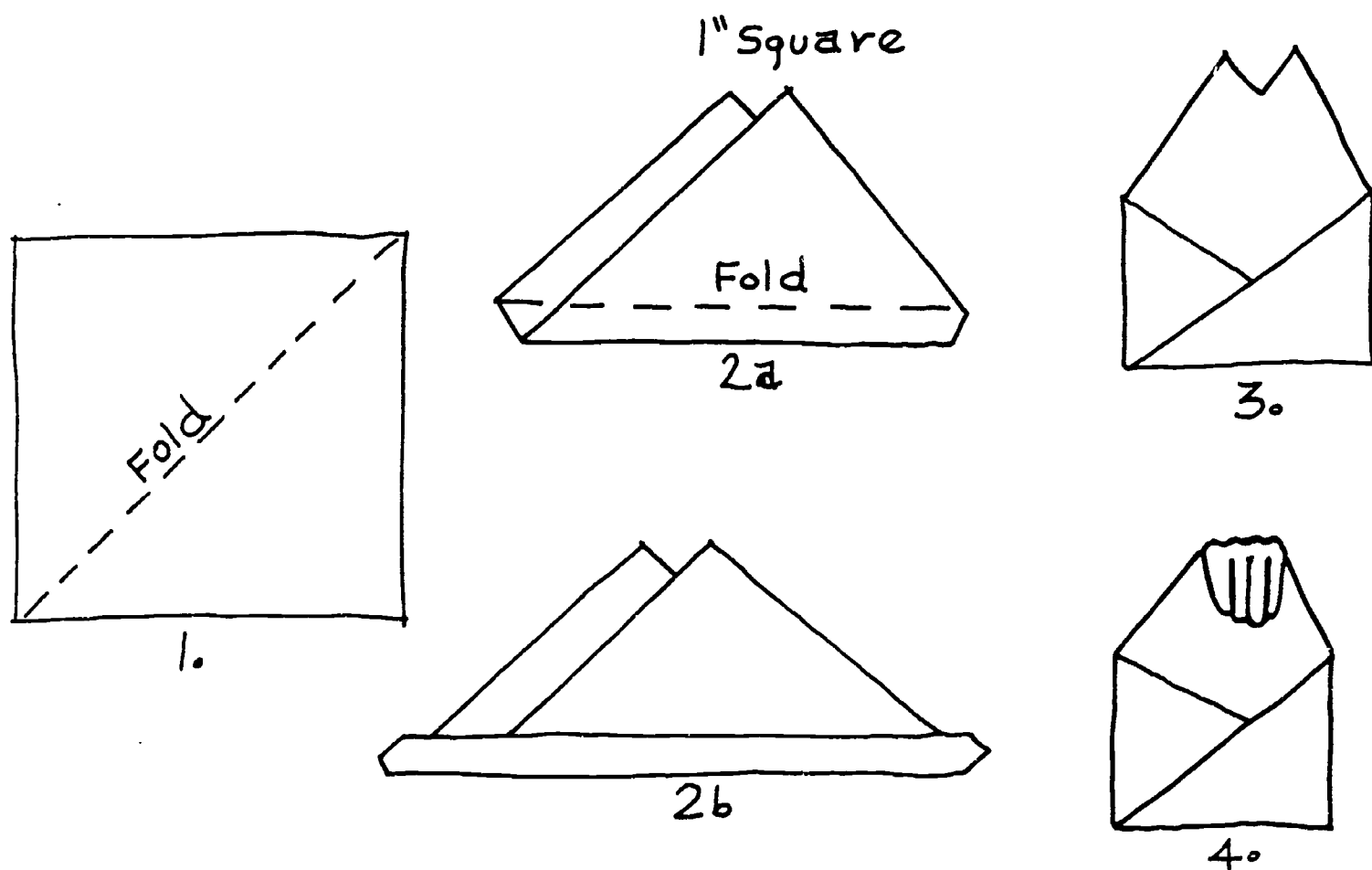

1. Fold paper diagonally so that upper edges leave about 1" square space.
- 2a–2b. Fold bottom edge up about 1".
3. Bring outside edges together, tucking one inside the other.
4. To fly the air foil, pick up in the manner suggested in the diagram. Hold over head and throw as if throwing a baseball overhanded . . . Then watch it fly!!

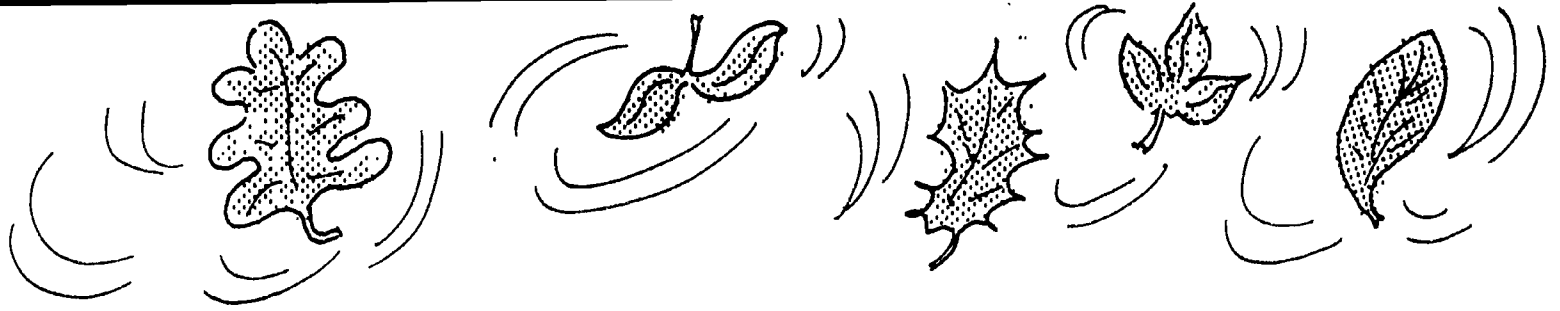

Have you ever watched the aerobatics of fall leaves dancing on the wind? Why do some leaves spin? Some float? Some glide? Gather an assortment of leaves and compare their size, shape, and weight. You might make a similar comparison to various seeds that are spread by the wind. How do “floating” seeds differ from other kinds of seeds?

Try this paper helicopter. Does it fly like any of the leaves or seeds you have observed?

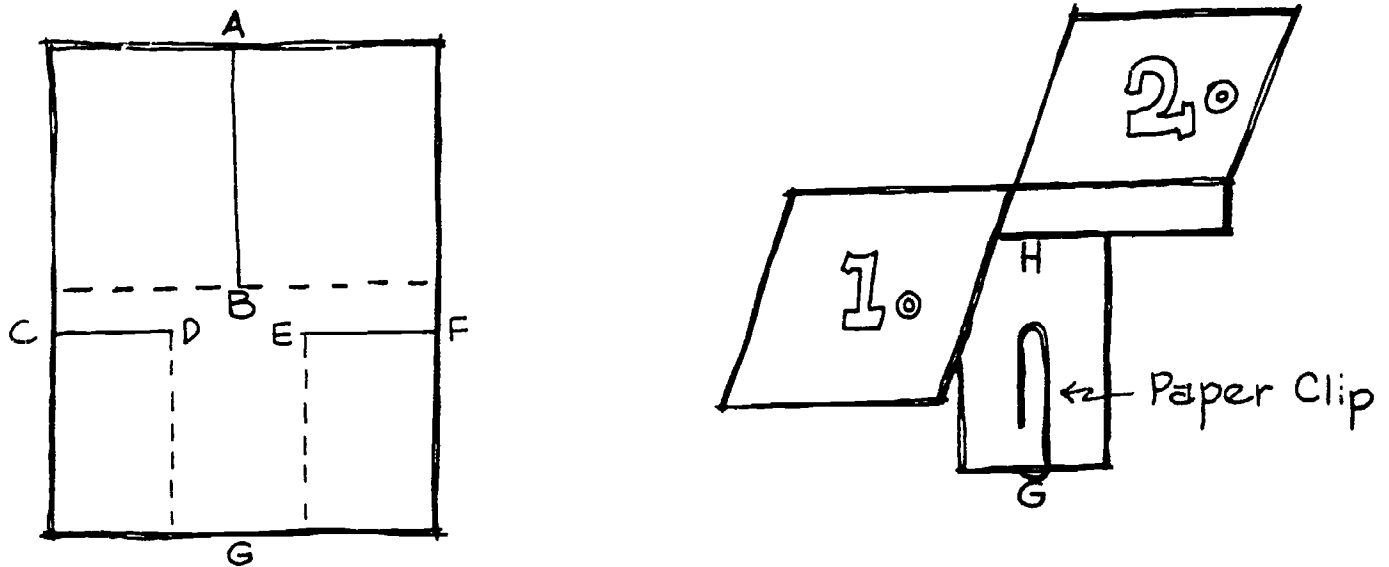

Cut an 8 1/2" x 11" piece of paper into fourths. Each quarter sheet will make one helicopter. Following the illustration, fold each sheet in half and cut from A to B. Cut from C to D and F to E. Fold F to D and C to E. Paper clip together at G and staple at H. Fold down wings 1 and 2. Hold high, spin, and let go.

MATERIALS:

Square sheet of paper
Straight pin
Pencil with eraser
Scissors

Fold the paper diagonally.

Fold it again when you open the paper and creased through it.



. Now,

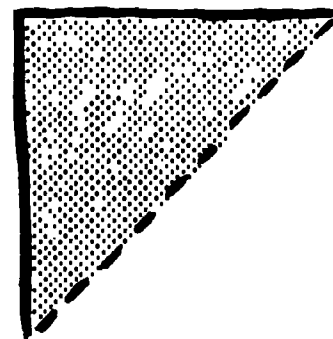

lay it out flat, it will have an "x"

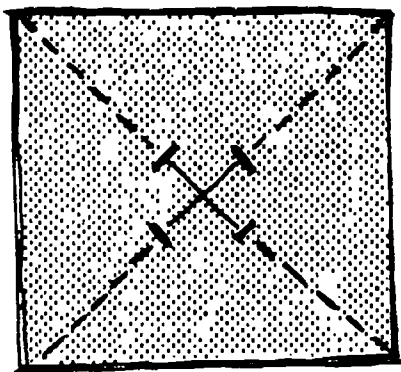

Cut along each fold to within one inch of the center. Pick up one corner and hold it in the center. Do this with each of the

other corners. Keep them in the center by sticking a straight pin through them, then stick the pin through the eraser. Move your windmill through the air and watch it spin!

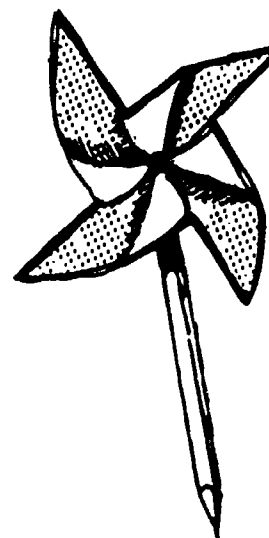

MATERIALS:

1 soda straw — 1 cup lid
 1 coffee stirrer — Thread
 1 piece string, 20 " long
 Scotch tape

Most of the materials used to make this fun flyer can be collected from the many fast food establishments around.

Notch one end of the straw. Tape a piece of thread across the opening in the  cup lid. Put the cup lid on the notched end of the straw, placing the thread in the notches. Insert a coffee stirrer in the other end of the straw. Wind a string around the lower portion of the straw.

When you are ready to launch, hold the stirrer

in one hand and pull the string rapidly. Try variations of lids, cutting slits in them etc., to change glide, height and so on.

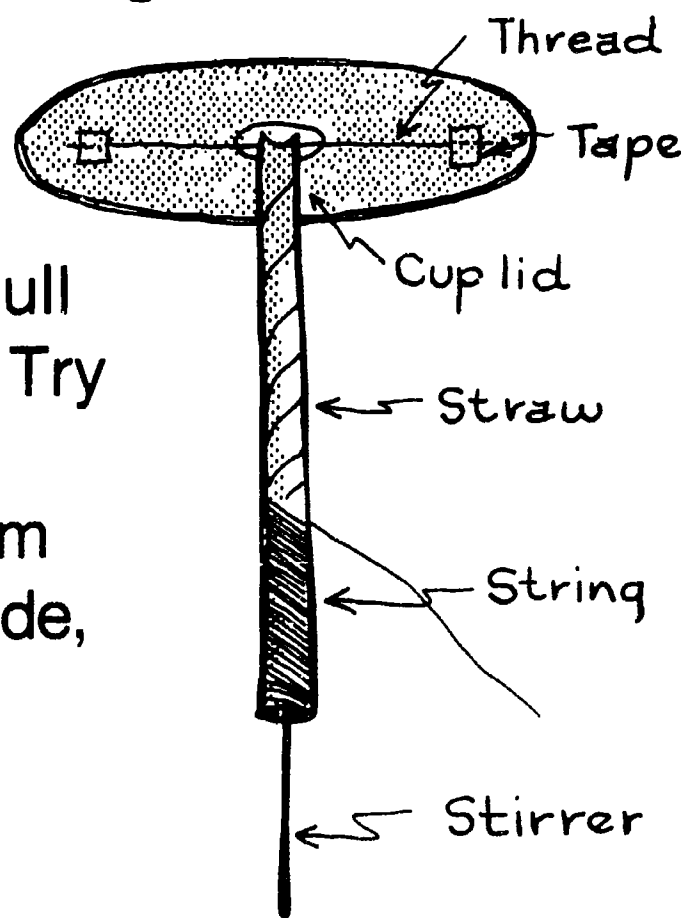
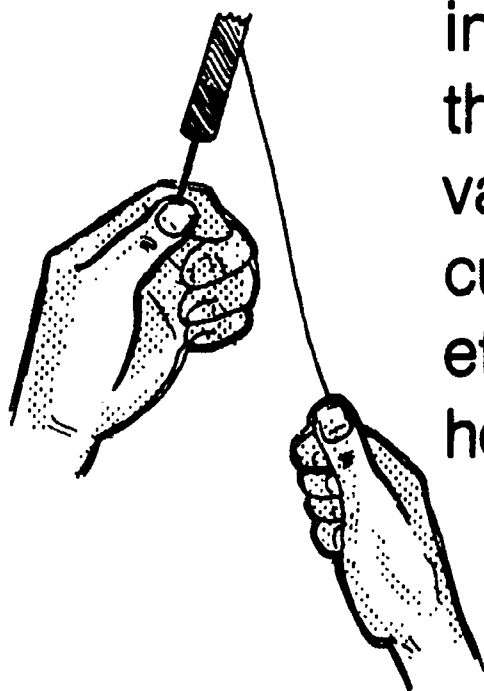

NONPOWERED FLIGHT

- LA—1 DOES AIR HAVE WEIGHT?
- LA—2 WHICH IS HEAVIER?
- LA—3 WHY DO OBJECTS FLOAT?
- LA—4 H₂O HAS IT!
- LA—5 IT'S FULL OF HOT AIR!
- LA—6 WHAT HAPPENS WHEN AIR IS HEATED?
- LA—7 WHERE DOES HOT AIR GO?
- LA—8 IT'S IN THE BAG!
- LA—9 UP, UP, AND AWAY!
- LA—10 WARM UP
- LA—11 BUBBLES UP!
- LA—12 HOW CAN YOU CONTROL TEMPERATURE IN A BALLOON?
- HA—1 RIDE THE WIND
- HA—2 NATURE'S HELICOPTERS.
- HA—3 MAKE YOUR OWN WINDMILL
- HA—4 GYROCOPTER A LA McDONALD'S

BIBLIOGRAPHY

Gottlieb, William P. *Aircraft and How They Work*. New York: Garden City Books, 1960.

Martin, Elizabeth F., ed. *Aerospace Activities for Learning and Fun*. Mobile: University of South Alabama.

DeVries, Leonard. *The Book of Experiments*. New York: The Macmillan Company, Inc., 1958.

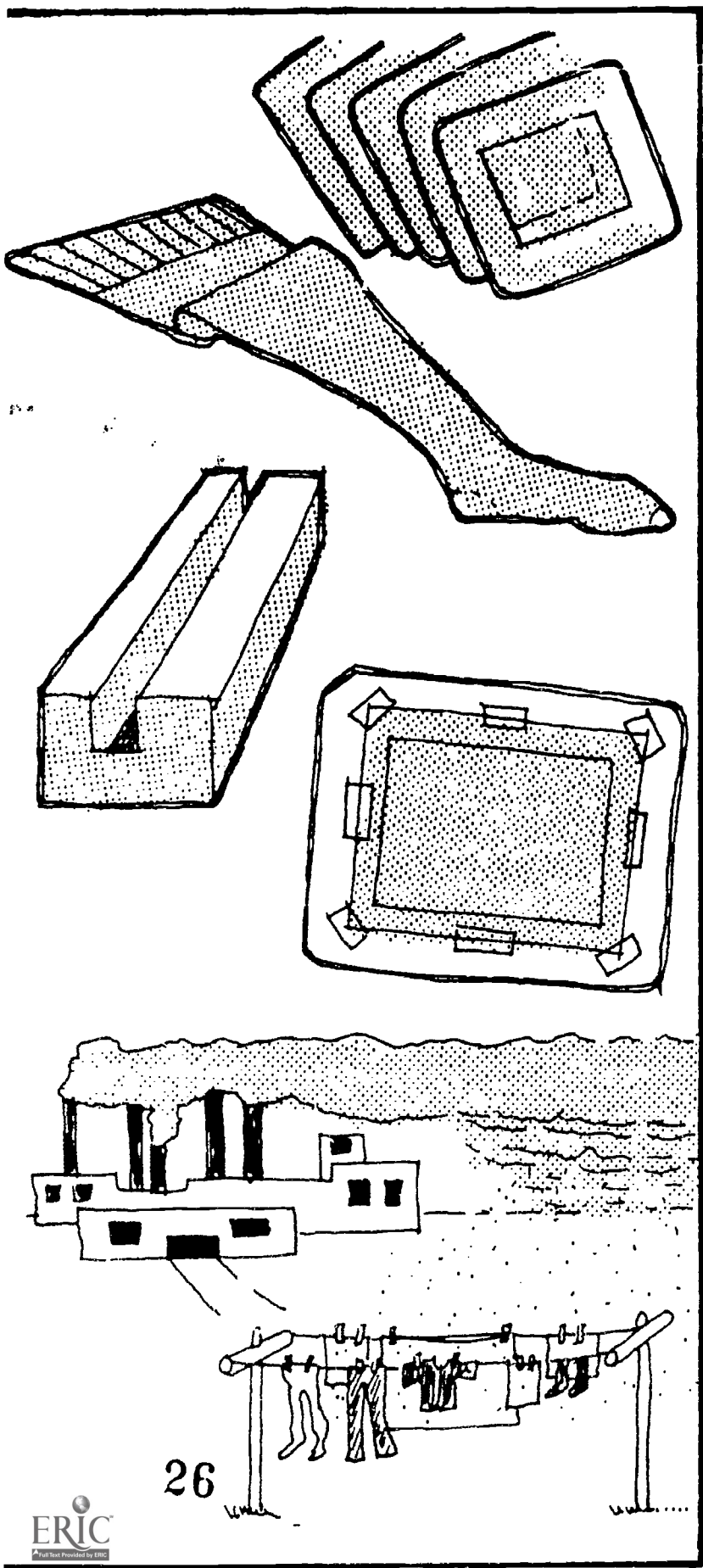

DEPARTMENT OF TRANSPORTATION
FEDERAL AVIATION ADMINISTRATION

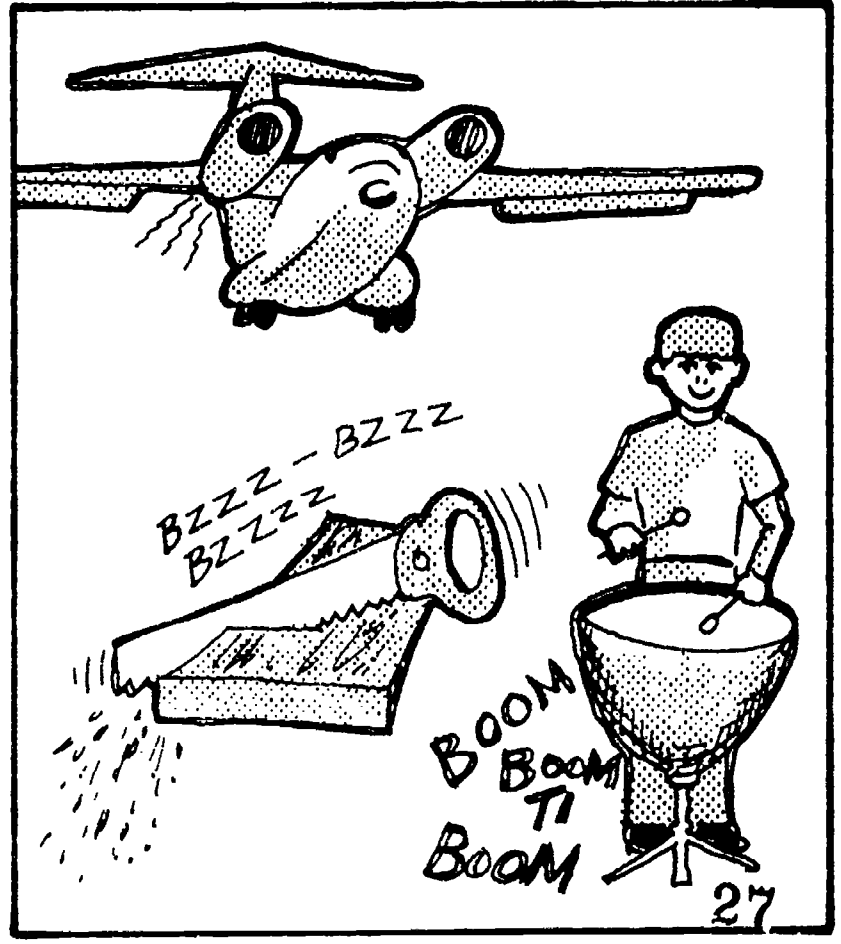
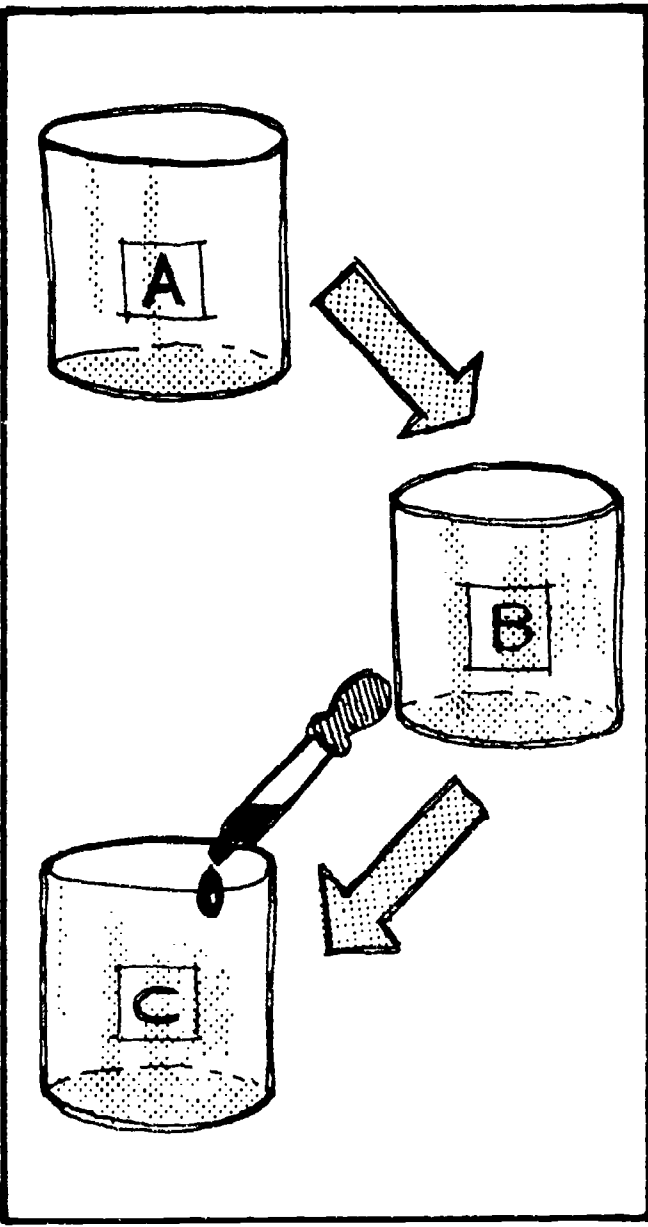
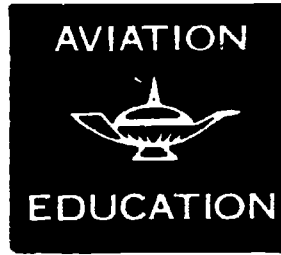
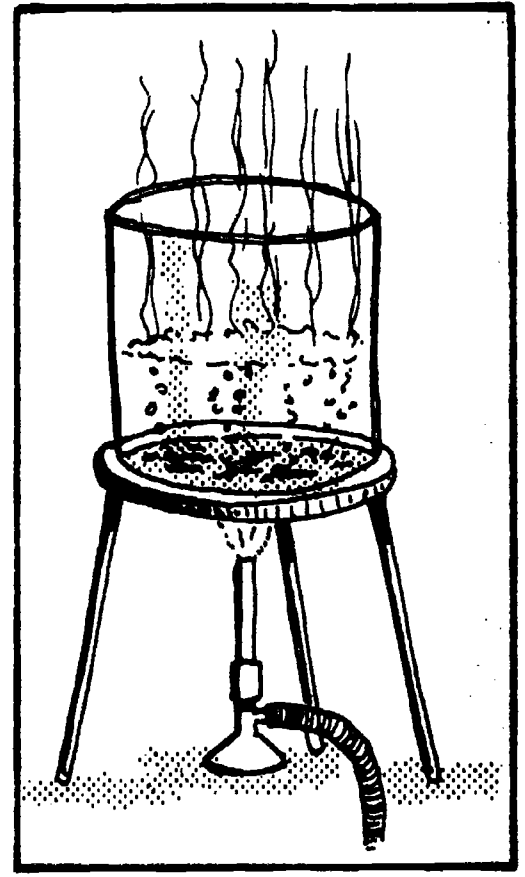



TEACHER'S INFORMATION

Demonstration Aids for Aviation Education—Volume II is a series of simple, concrete, revealing experiments developed by the Civil Air Patrol Center for Aerospace Education Development for the Federal Aviation Administration specifically for upper elementary grades. These activities can be adapted to meet the needs of varied teaching situations and different grade levels.

These materials are primarily designed as pupil directed experiences. In some instances the teacher may want to further extend the investigations. This series is intended to be a springboard for your own ideas to demonstrate concepts of the Air Age to your students. Young children can learn scientific principles through simple learning activities; older students can benefit from a review using the same activities.

The purpose of this series is to illustrate certain principles related to various concepts of aviation and space. More important, it is an opportunity for you to directly involve students in investigations and in making discoveries on their own.

You needn't be an "expert" in science to use this material. In fact, you shouldn't be expected to have all the correct answers to the questions presented in the material. Moreover, many of the activities are designed to include interdisciplinary skills and need not be used in sequence.

Each packet in the series forms a coherent program of instruction on a single topic: Non-powered Flight, Aerospace and the Environment, Space Exploration and Communications. Most of the tasks are introduced as a question. In order to answer the question, the students may want to first predict the solution. Then have them follow the activity instructions to arrive at an answer. This kind of student involvement may lead to other related questions generated by the teacher, other students, or suggested on the cards themselves.

Most of the activities utilize materials readily available from any given community and can be completed in the classroom. Others may require that you borrow some equipment from your science resource center or from a junior or senior high school in your district.

Please let us know your reactions to the materials. We would like to hear your suggestions and information related to aviation or space. We will be glad to supply you with any additional information you use these packets.

Written by Mr. Debbie Williams, and Mr. James Williams
Editorial Assistance by Mrs. Patricia Smith
Illustrated by Mr. Harley A. Sanford

AEROSPACE AND THE ENVIRONMENT

- AP-1 HOW MANY IS 1,000,000?
- AP-2 WHAT IS ONE PART PER MILLION (1 P.P.M.)?
- AP-3 HOW CAN WE MEASURE AIR POLLUTION?
- AP-4 HOW CLEAN IS THE AIR AROUND YOU?
- AP-5 HOW DOES POLLUTION AFFECT CLOTHING?
- NP-1 WHAT IS NOISE?
- NP-2 WHERE DID THE NOISE GO?

BIBLIOGRAPHY

Tannebaum, Beulah and Stillman, Myra. *Clean Air*. New York: McGraw Hill, Inc., 1973.

Laycock, George. *Air Pollution*. New York: Grosser & Dunlap, 1972.

DOT, FAA. *Aircraft and the Environment*. Washington, D.C.: U.S. Government Printing Office, 1973.

**HOW
MANY
IS**

1,000,000

**AP-1
ONE MILLION?**



Air pollution is a serious problem in today's world. Pollutants are measured in parts per million (ppm). A million is difficult for us to

understand. It is: 1000×1000 or $100 \times 10,000$ or $10 \times 100,000$ or $1,000,000$. That's a lot to count. Let's find out how many 1,000,000 is.

MATERIALS: Construction paper, scissors, scotch tape, rice, 10 pennies, balance (or postage scale), deck of playing cards, ruler

Use construction paper to build a box 1 inch on each side. Fill the box with rice

(level to the top). Count the number of grains of

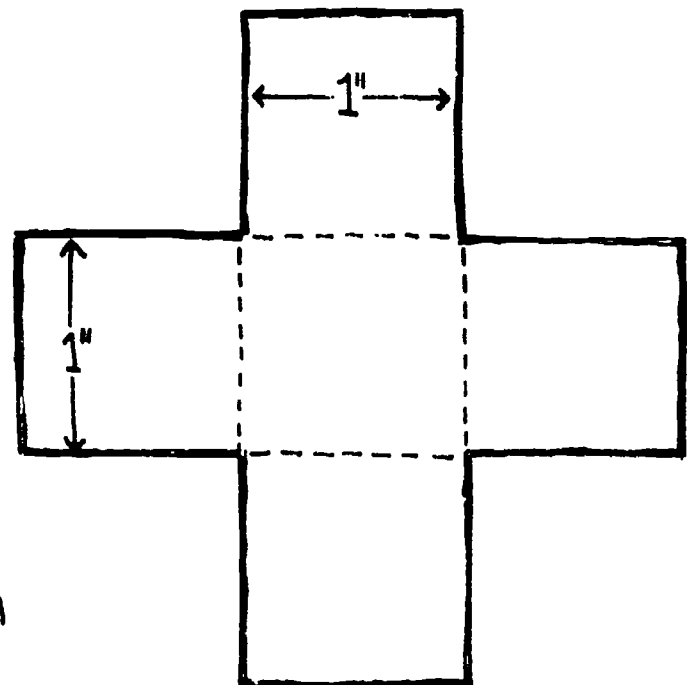
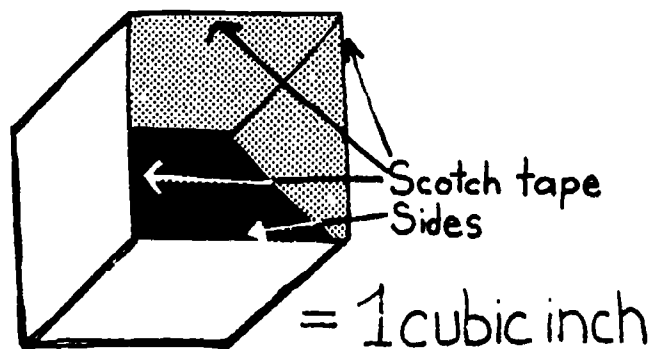

rice in the box. How many cubic inches

would a box have to be to hold 1,000,000 grains of rice?

Place 10 pennies on the balance scale. How much do they weigh? How much would 1,000,000 pennies weigh?

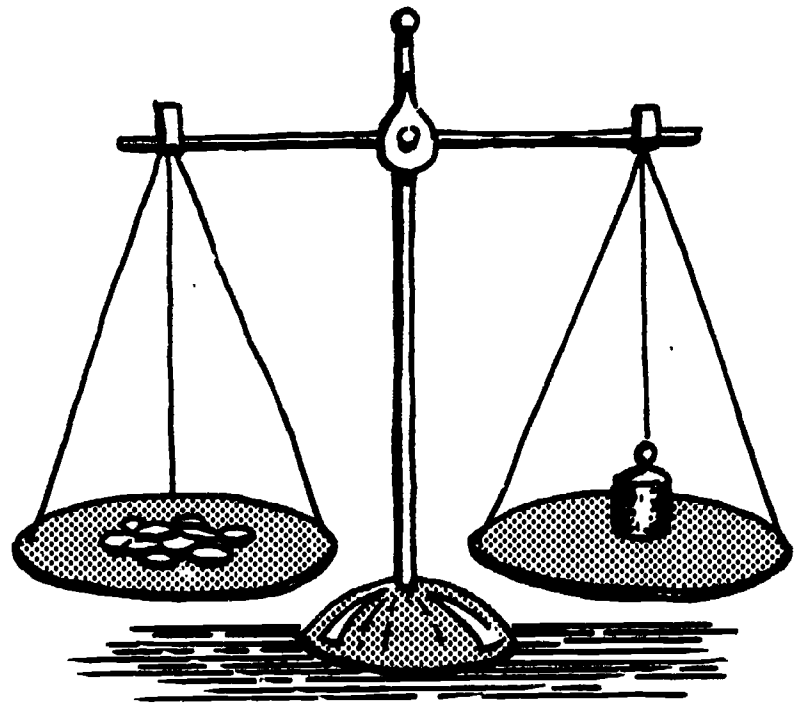

Remove 2 cards from a deck of playing cards (leaving 50 remaining). Use a ruler to measure the thickness of the stack. How thick is the stack of 50 cards? How high would a stack of 1,000,000 cards be? In inches? In feet? In meters?

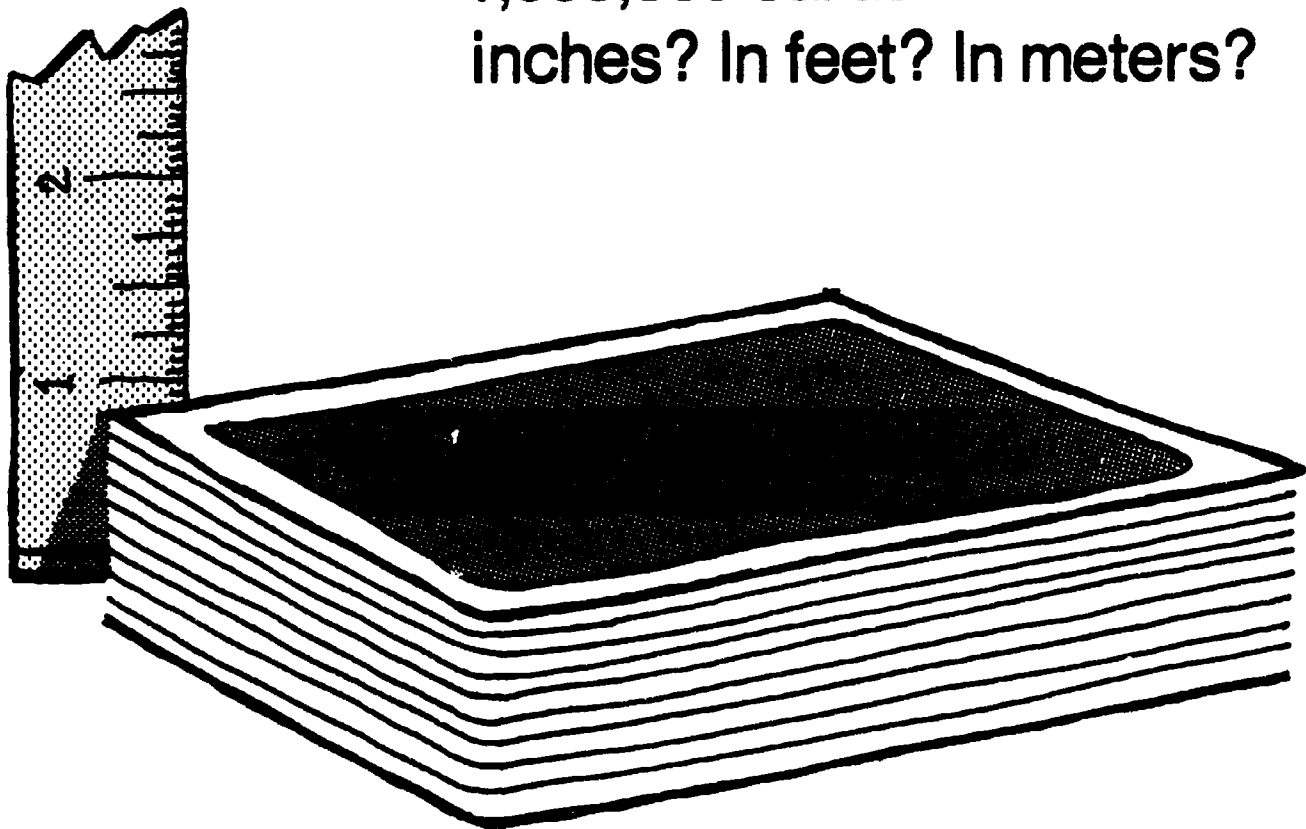

WHAT IS ONE PART PER MILLION (1 P.P.M.)?

AP-2

MATERIALS:

Food coloring, water, eye dropper, 3 small beakers, peppermint flavoring.

Put 99 drops of water into a small beaker labeled "A."

Add one drop of food coloring for a total of 100 drops. Stir well. The food coloring measures one part per 100, or 1/100.

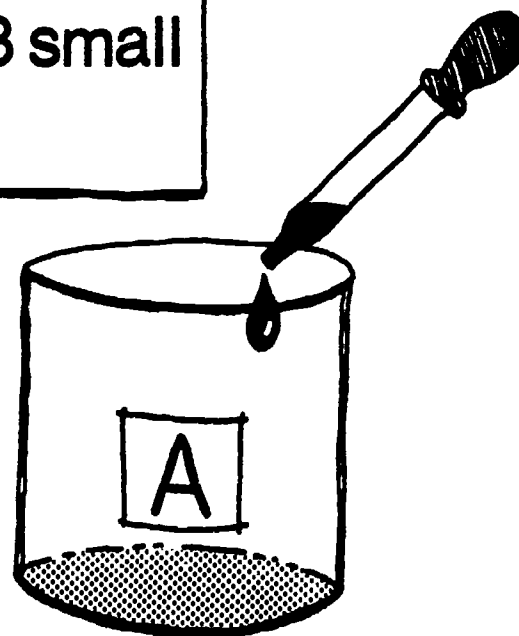

Put 99 drops of water into another small beaker labeled "B." Add one drop from beaker "A" for a total of 100 drops. Stir well. The food coloring in beaker "B" is now one part per 10,000 or 1/10,000 ($1/100 \times 1/100$). Can you still see the color?

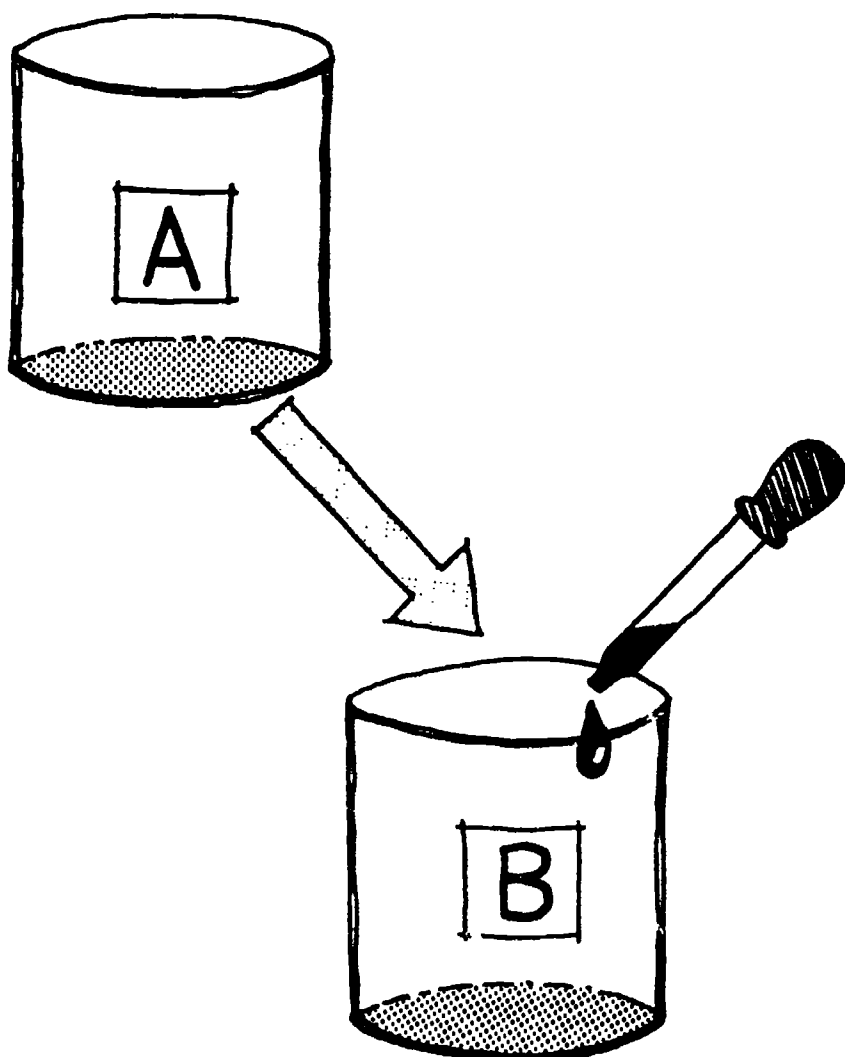

Put 99 drops of water into another beaker labeled "C." Add one drop from beaker "B" for a total of 100 drops. Stir well. The food coloring in beaker "C" is now one part per million ($1/100 \times 1/10,000$). Can you still see the color?

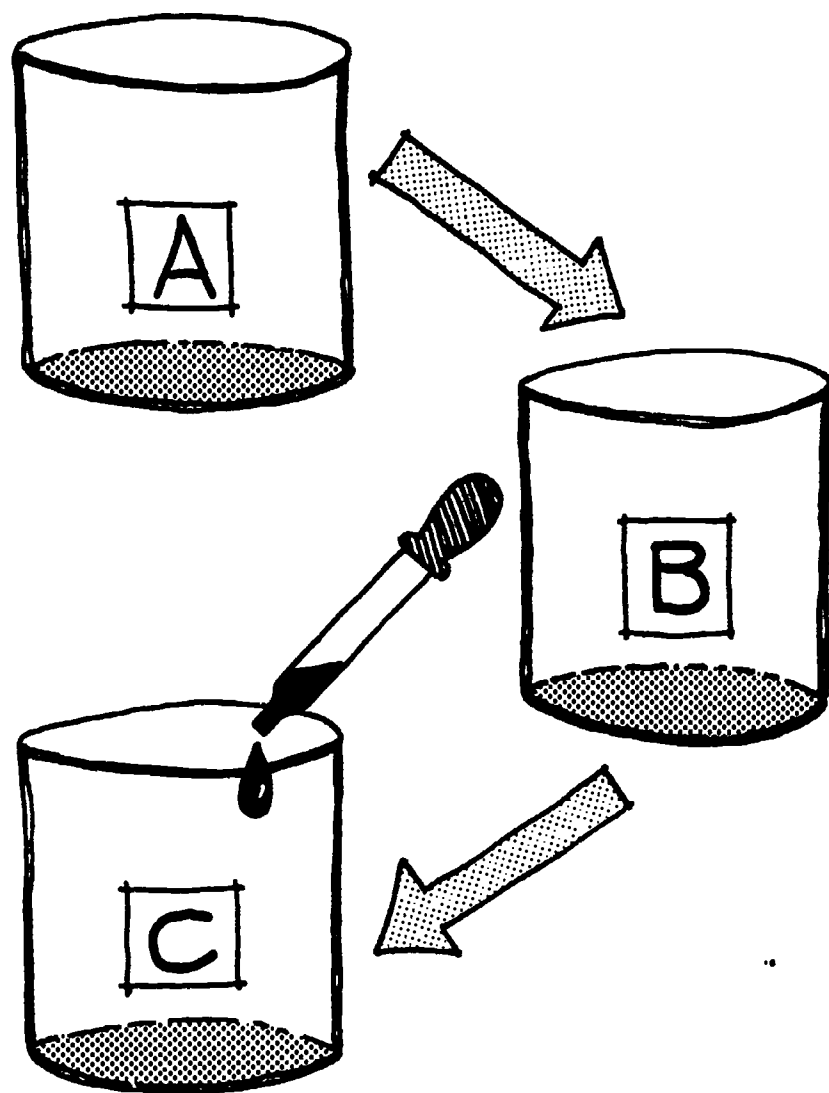

Repeat the experiment using 2 or 3 drops of food coloring in beaker "A" to see how many P.P.M. must be present to be seen. Remember the total number of drops in each beaker must be 100.

You may also want to repeat the experiment using peppermint flavoring instead of food coloring. You can compare your senses of sight, smell, and taste.

HOW CAN WE MEASURE AIR POLLUTION?

AP-3

MATERIALS:

Deep glass container, distilled water, heat source, balance, weights

Choose an open area away from trees and buildings. Place the glass container half filled with distilled water in position for 30 days. Keep adding water to the container to trap dirt falling into it.

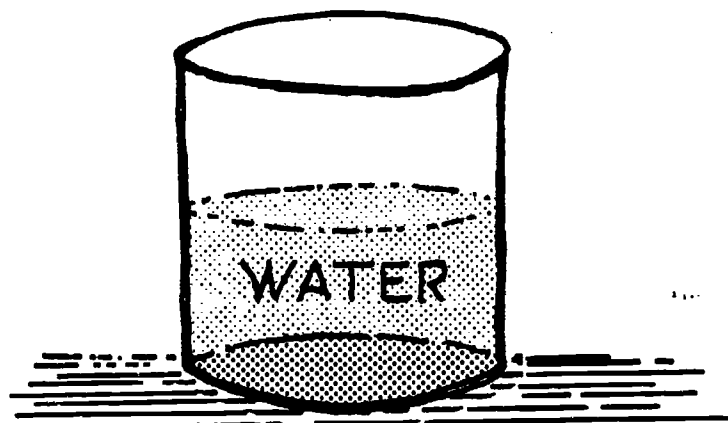

Evaporate the water over low heat being careful not to burn the collected materials in the bottom of the container.

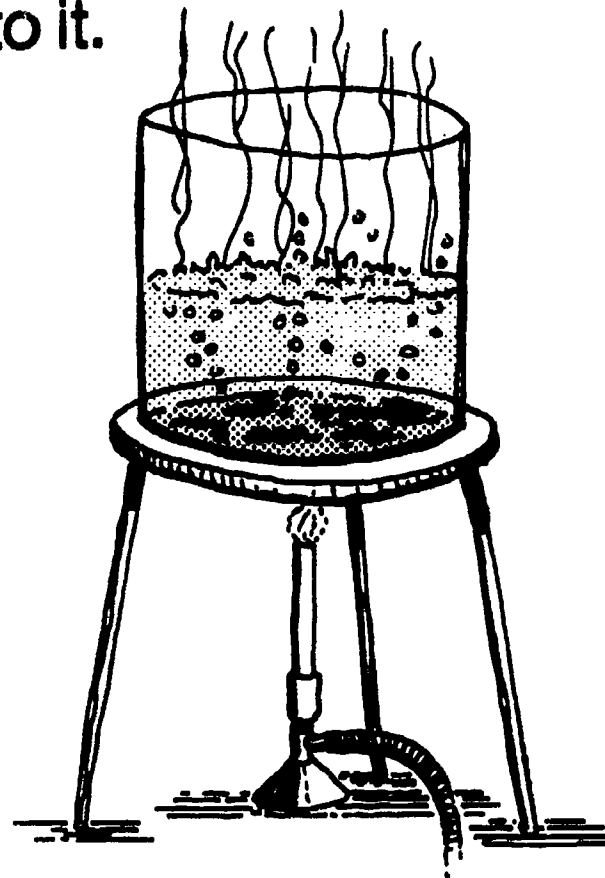

Weigh the container and its contents. Wash and dry the container.

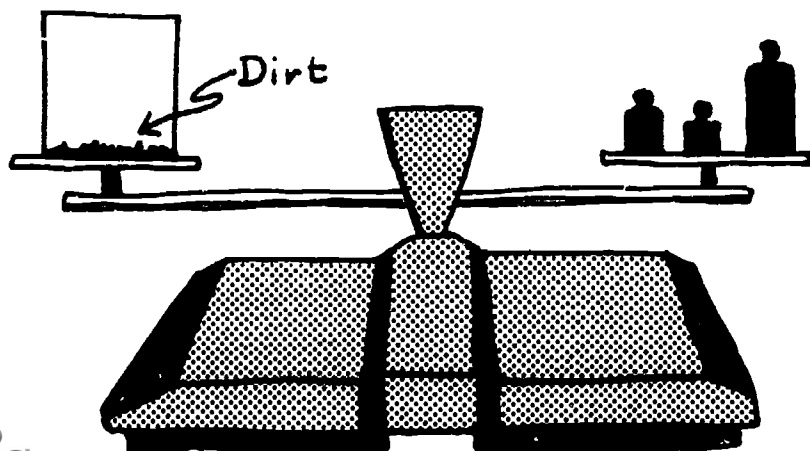

**Weigh the container again.
The difference is the weight
of the dirt collected.**

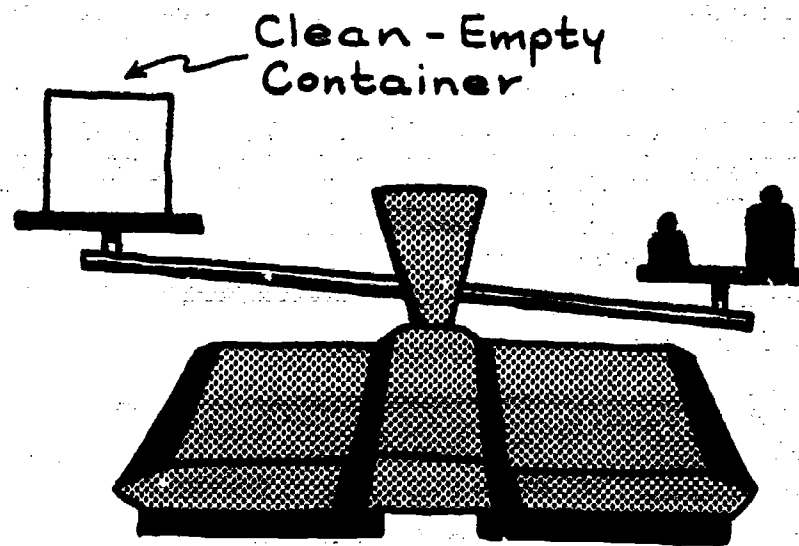

Find out how much dirt falls per square inch, per square foot, per square mile. HINT – How many square inches is the opening in your container? Area of a circle = πr^2 . If you divide the weight of the dust collected by the area of the opening you will have the amount of pollutants per square inch. How many square inches in a square foot? _____ How many square feet in a square mile? _____

HOW CLEAN IS THE AIR AROUND YOU?

AP-4

Some pollutants found in the atmosphere from vehicles and factories

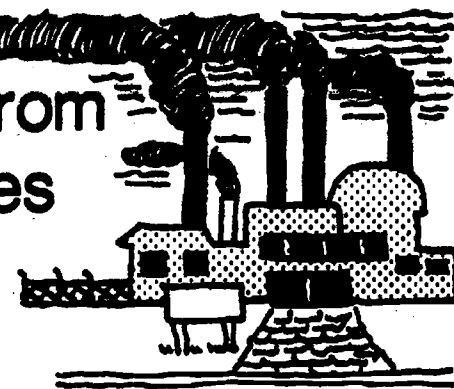
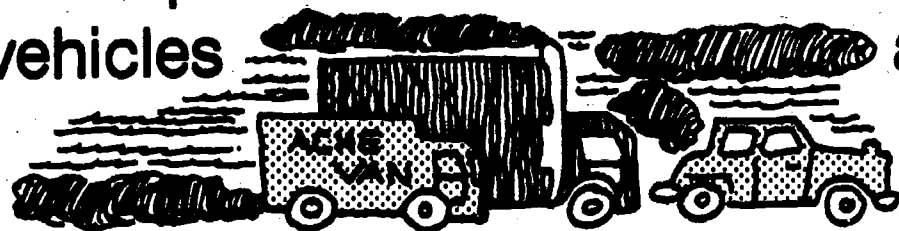

are magnetic
you will need:



To find some of these

MATERIALS:

Small magnet, string, plastic sandwich bag, tape, soda straw.

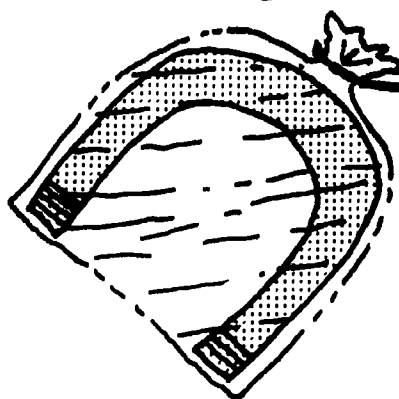

Place the magnet inside the bag and tie the string around it.

Select a measured area 5 feet by 5 feet and move the bag over the area touching the ground. Collect the material in a soda straw sealed with tape.

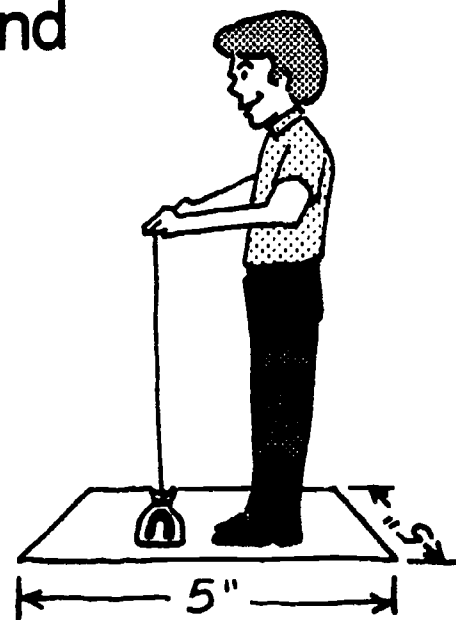
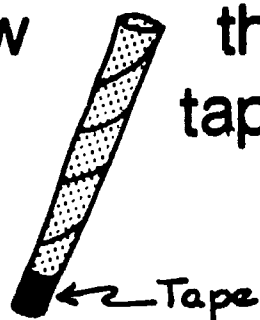

Compare the amount of material found in different locations. Use the same size area — 5 feet x 5 feet.

Try an area near a highway or busy street — on the school playground — in the country — near a factory — etc.

HOW DOES POLLUTION AFFECT CLOTHING?

Pollution in the air causes damage to clothing every year. Pollutants such as nitrogen oxides, sulfuric acid, and hot smoke particles destroy nylon.

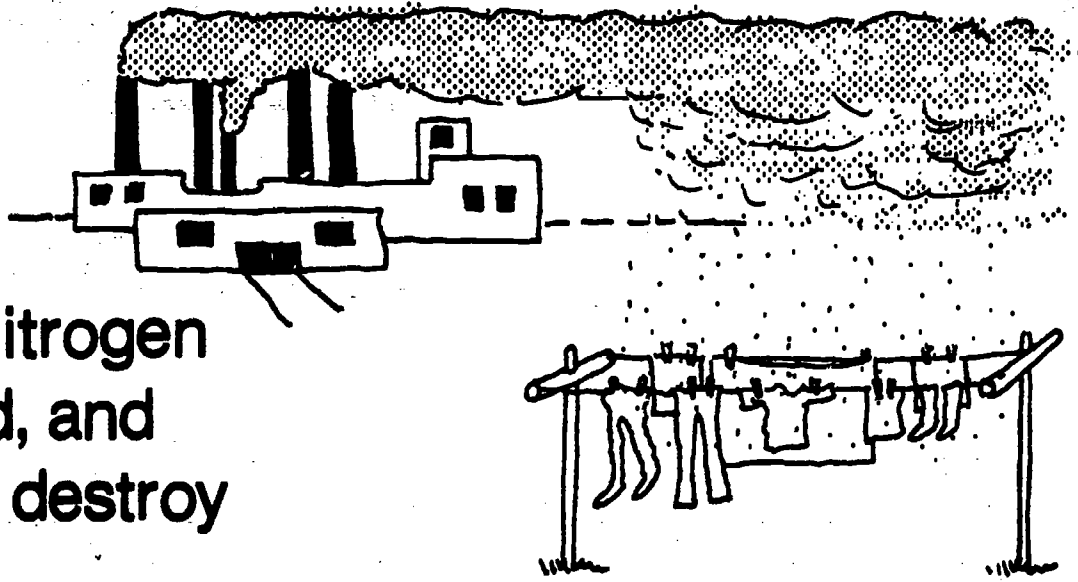

MATERIALS:

5-35 mm plastic slide mounts
nylon stocking
glue or tape

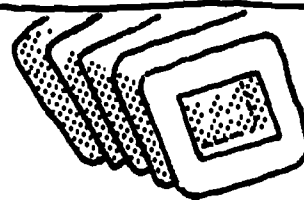
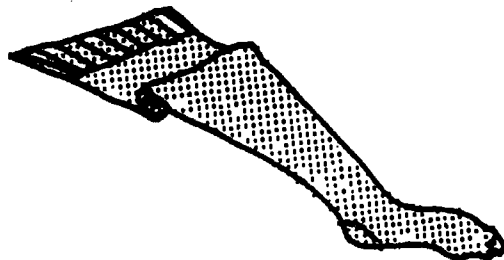

5-grooved wooden blocks

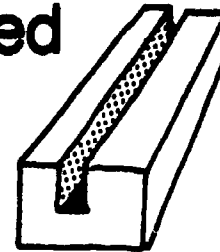

Prepare six experiments by cutting a square of nylon stocking to cover each of the 35 mm slide mounts. Stretch the nylon over each of the slide mounts and glue or tape in place.

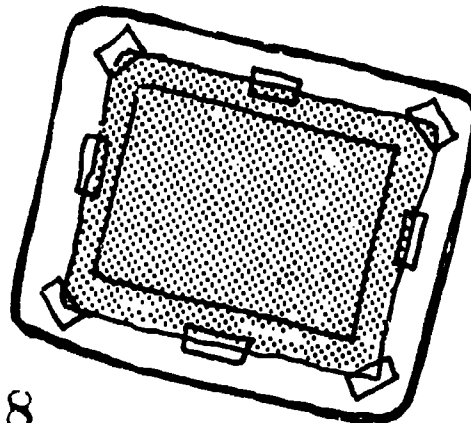

Mount each slide on one of the wood blocks so that it can stand upright.

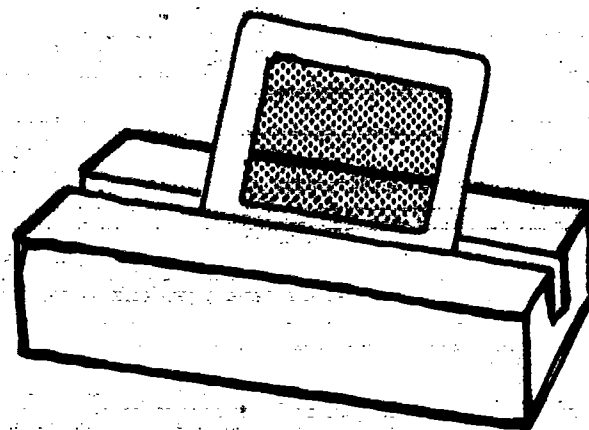

Select two outdoor locations such as the roof of the school or other building. Place two slides in each of the locations and keep one indoors for comparison. Leave one slide at each location for 30 days and the other in each location for 60 days.

You can best see the damage caused by the air pollution if you use a hand lens or a slide projector.

Find out how Webster defines noise. How would you define noise?

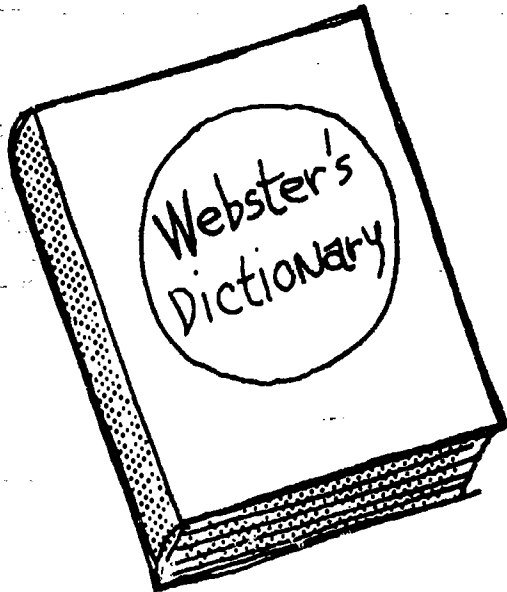
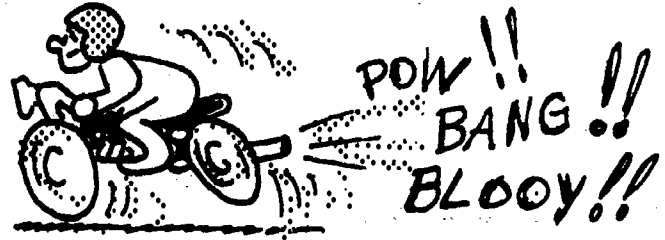
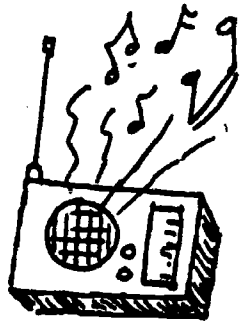

Make a list of things around you that make noise. Mark the ones that bother you.

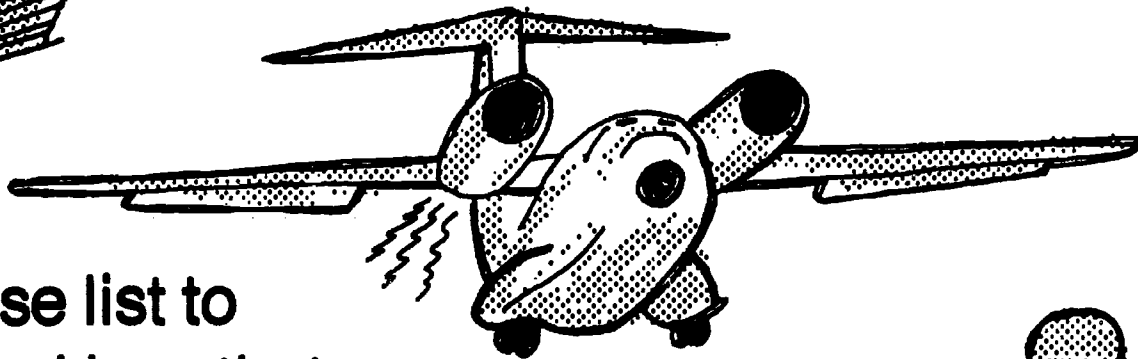
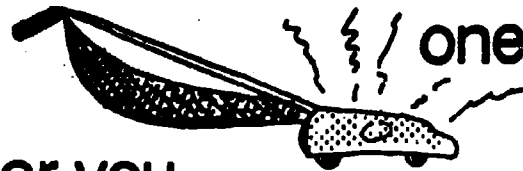

Give your noise list to someone else. Have that person mark the noises that bother him or her. Are you bothered by the same noises?

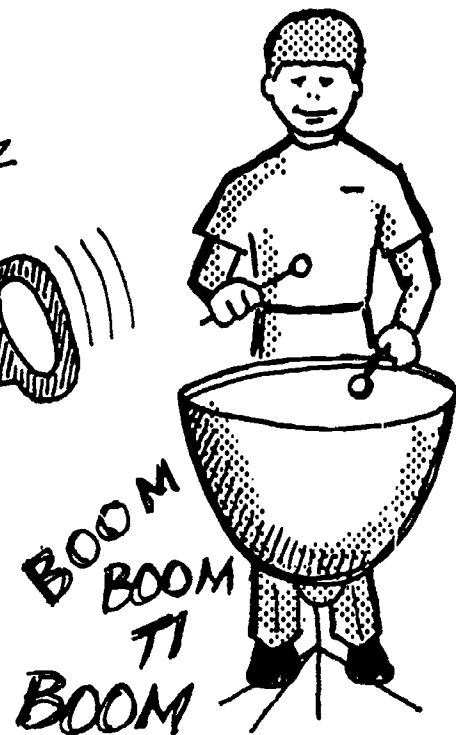
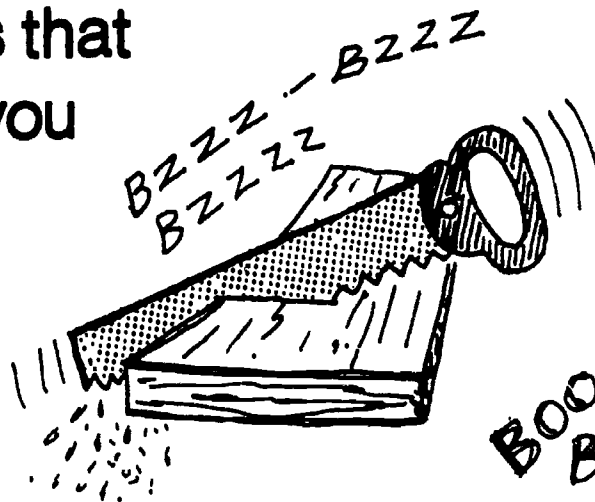
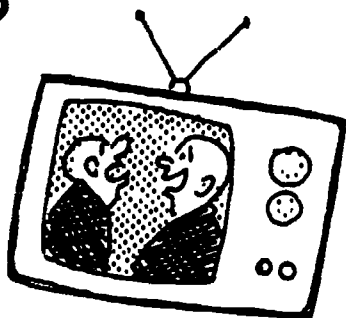

Can you list some noises that bother a lot of people — Would you say these noises contribute to noise pollution? Try to list some ways to make things less noisy.

What kinds of things can be used to absorb sound?
Will hard smooth things work better than soft rough things?

MATERIALS: Battery operated radio, cardboard box, staples, tape, samples of cloth, carpet, styrofoam, newspaper, etc.

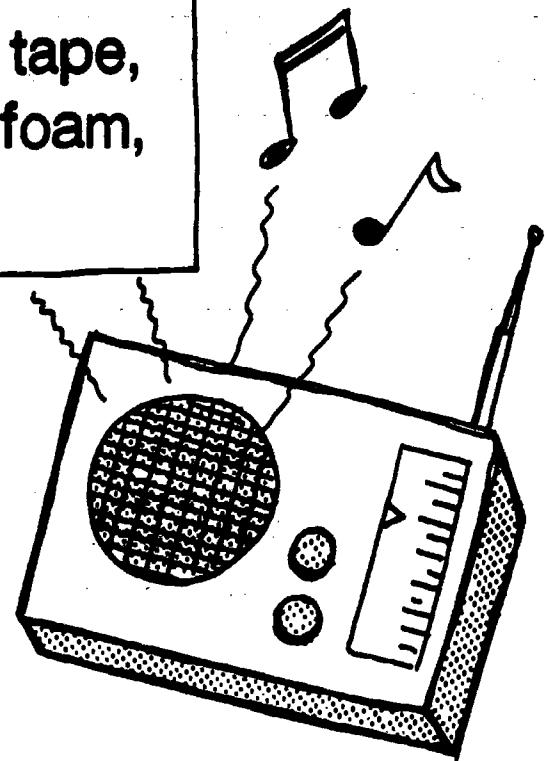

Turn on the radio and set the volume. Place the radio inside the empty cardboard

box away
can no

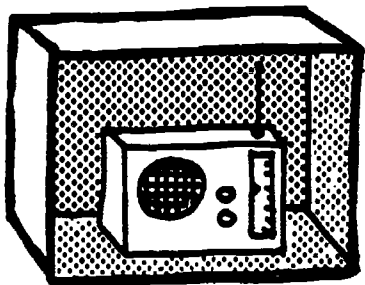

and seal the box. Move from the box until you longer hear the radio.

Carpet
Sample

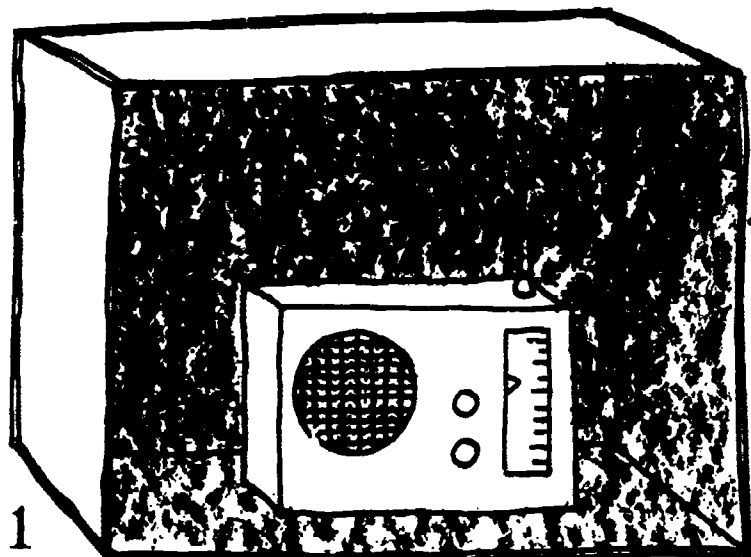

Measure the distance.
Line the inside of the box with the carpet samples.
Use the same volume setting as before.
Measure the distance again.

Repeat the experiment using the other materials. Which materials are the most effective?

How can you use what you have learned to make yours a quieter environment?

AEROSPACE AND THE ENVIRONMENT

- AP -- 1 HOW MANY IS 1,000,000?
- AP -- 2 WHAT IS ONE PART PER MILLION (1 P.P.M.)?
- AP -- 3 HOW CAN WE MEASURE AIR POLLUTION?
- AP -- 4 HOW CLEAN IS THE AIR AROUND YOU?
- AP -- 5 HOW DOES POLLUTION AFFECT CLOTHING?
- NP -- 1 WHAT IS NOISE?
- NP -- 2 WHERE DID THE NOISE GO?

BIBLIOGRAPHY

- 1. American Beach and Stillman Myra. *Clean Air*. New York: Grosset & Dunlap, 1975.
- 2. American Beach and Stillman Myra. *Clean Air*. New York: Grosset & Dunlap, 1975.
- 3. American Beach and Stillman Myra. *Clean Air*. New York: Grosset & Dunlap, 1975.

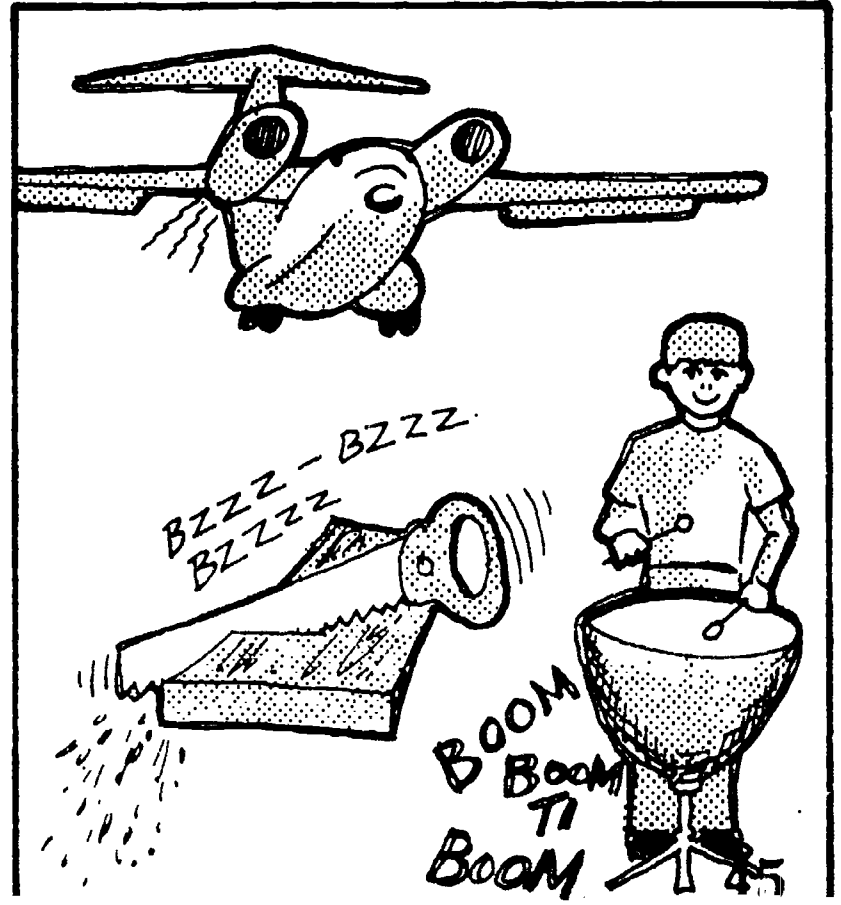
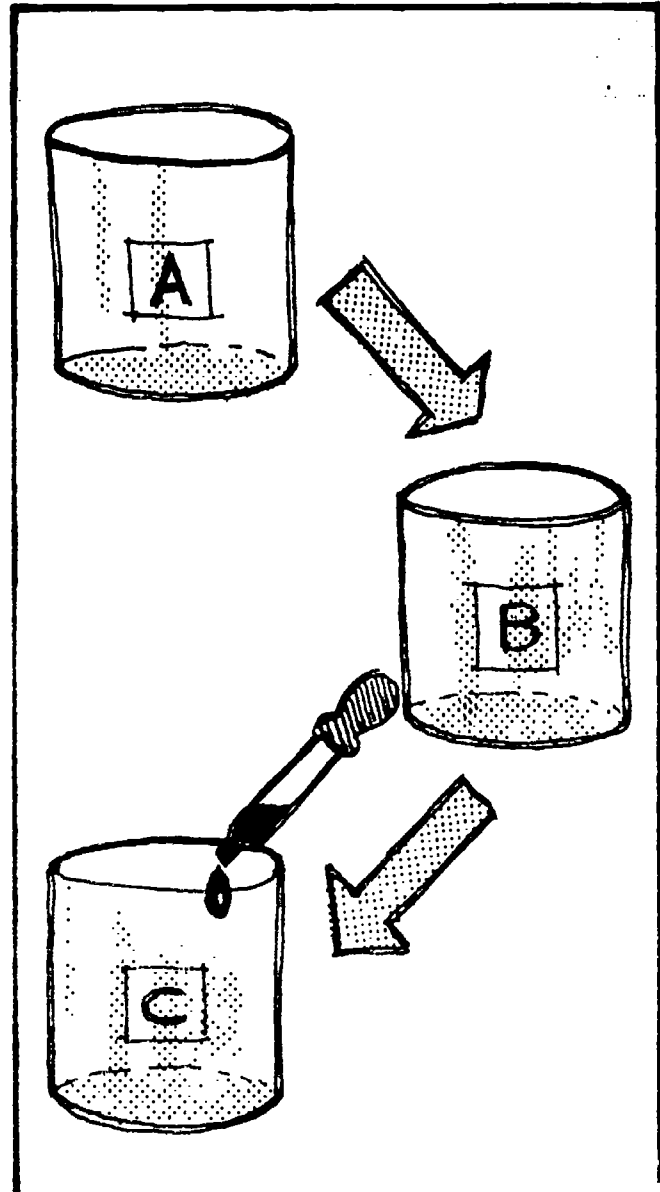
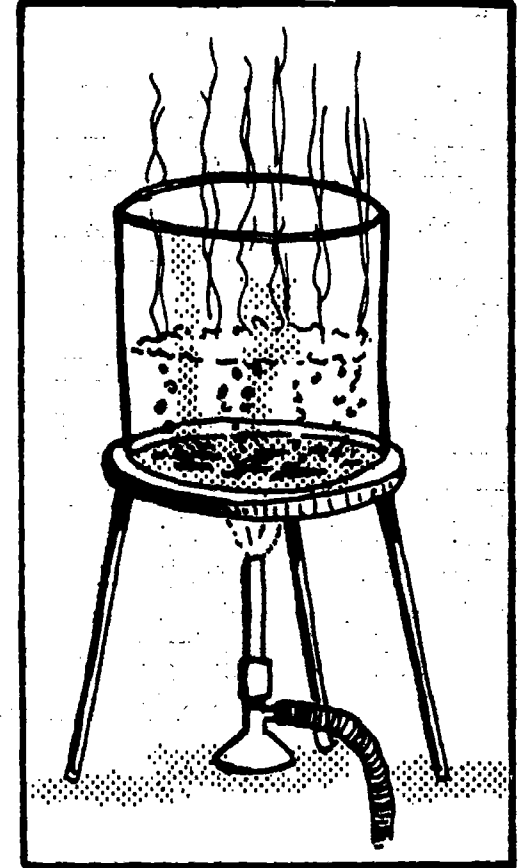
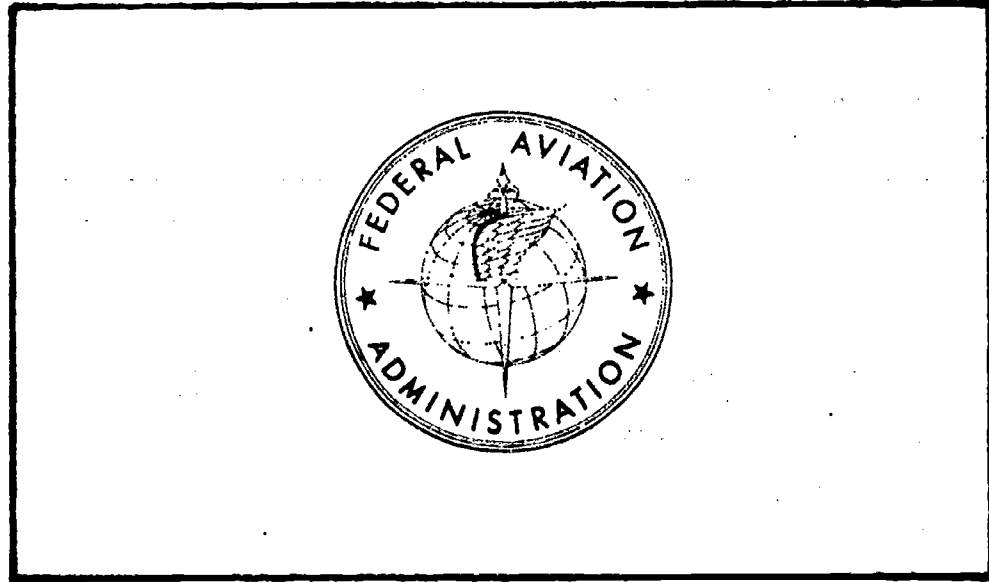
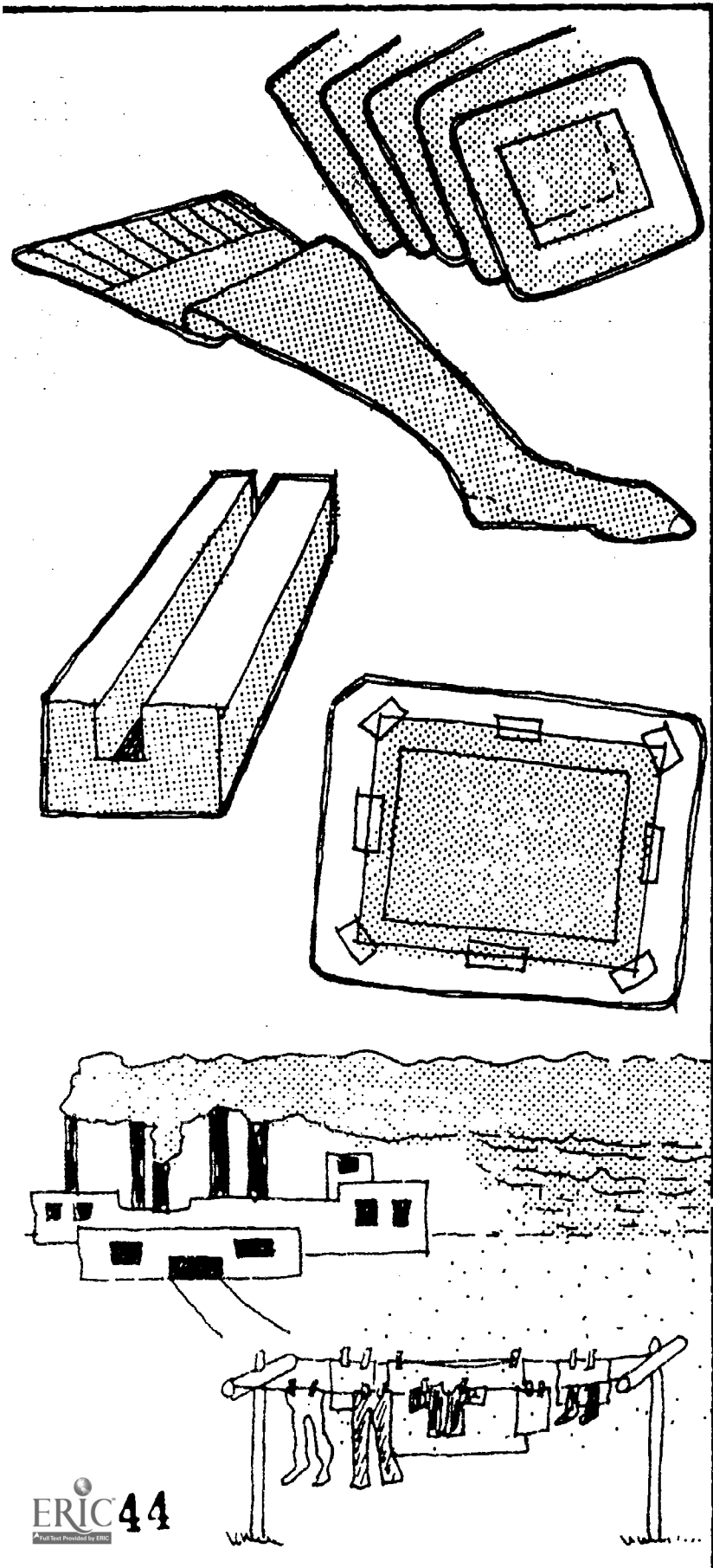

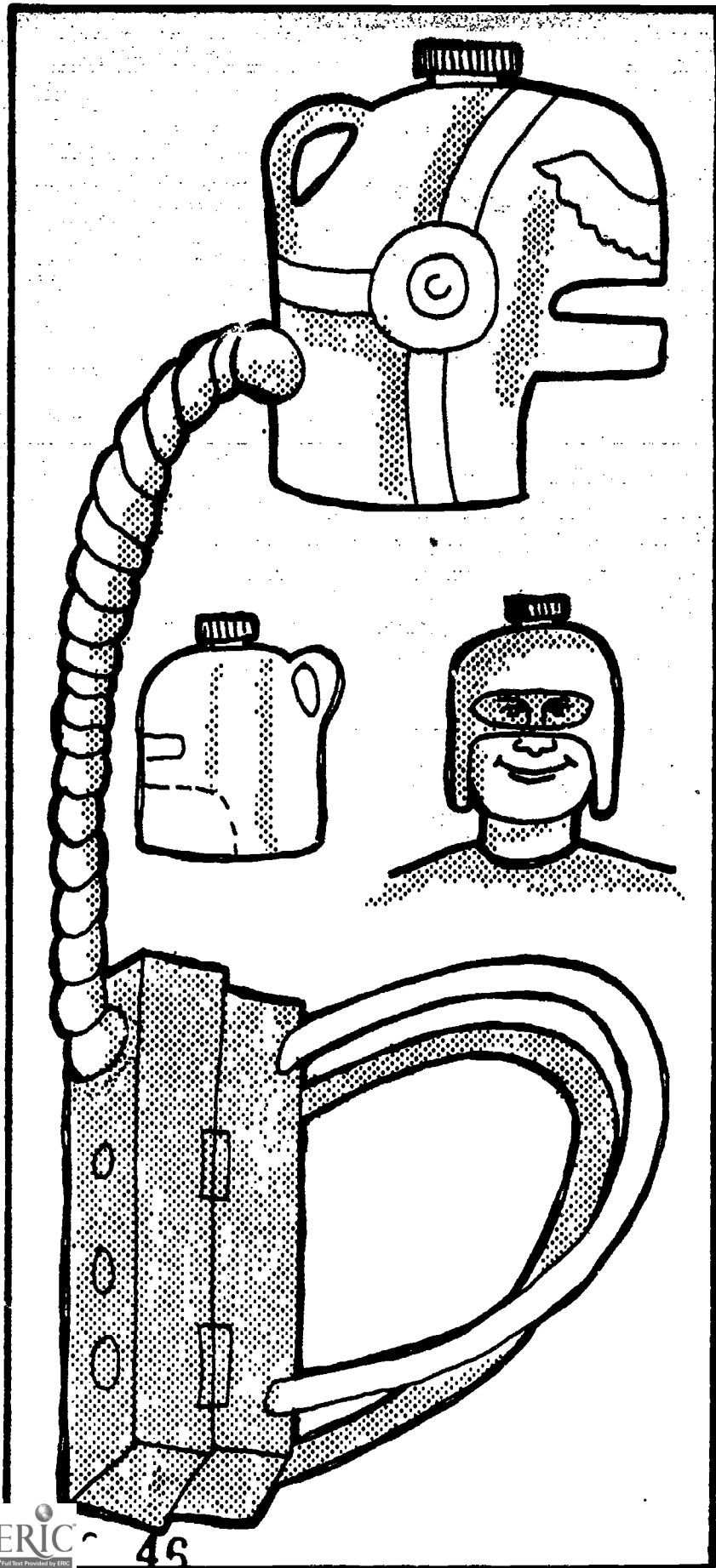

DEPARTMENT OF TRANSPORTATION
FEDERAL AVIATION ADMINISTRATION

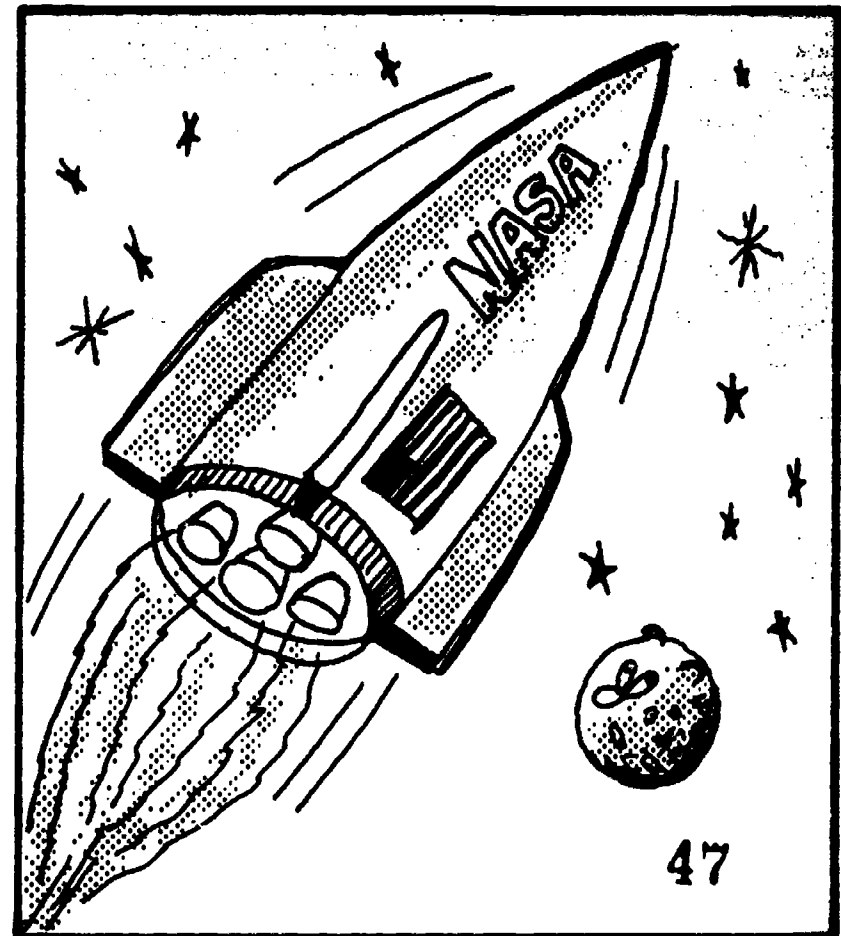
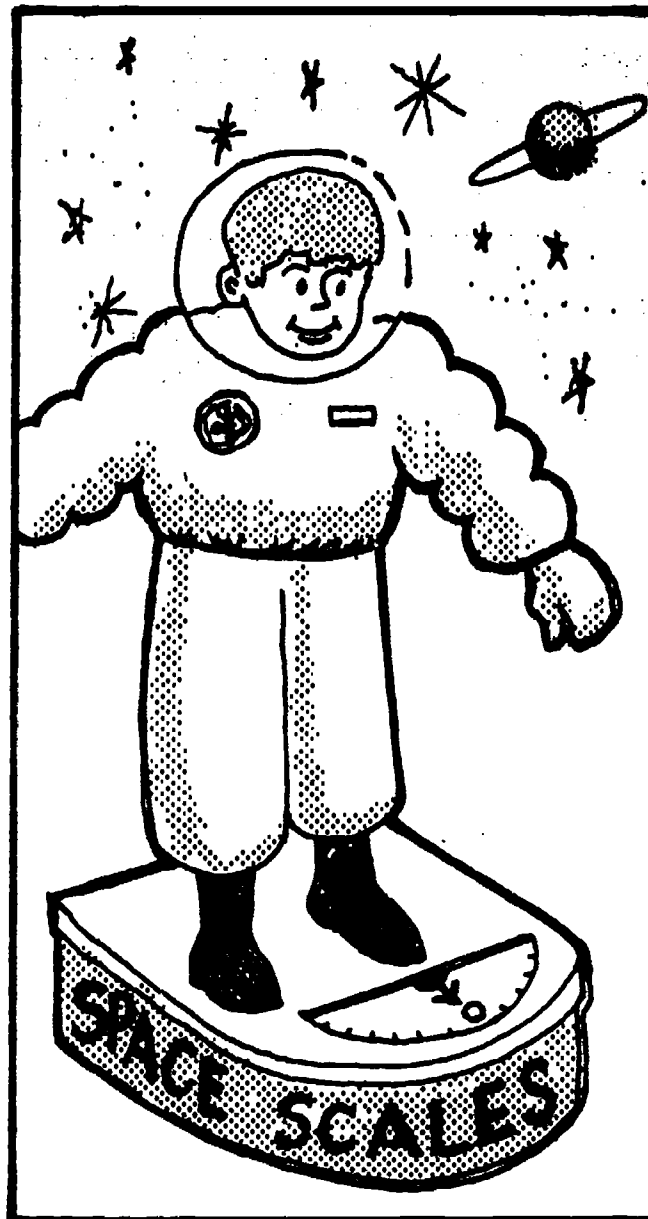
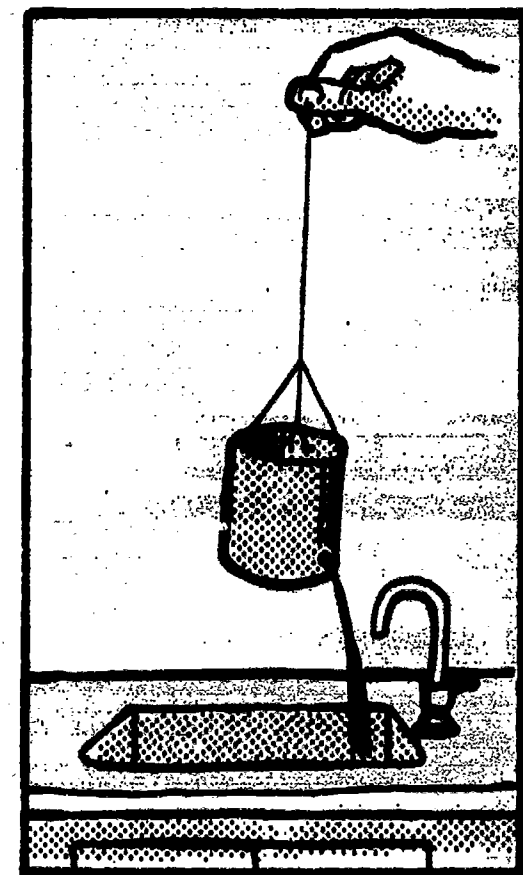



TEACHER'S INFORMATION

Demonstration Aids for Aviation Education— Volume II is a series of simple, concrete, revealing experiments developed by the Civil Air Patrol Center for Aerospace Education Development for the Federal Aviation Administration specifically for upper elementary grades. These activities can be adapted to meet the needs of varied teaching situations and different grade levels.

These materials are primarily designed as pupil directed experiences. In some instances the teacher may want to further extend the investigations. This series is intended to be a springboard for your own ideas to demonstrate concepts of the Air Age to your students. Young children can learn scientific principles through simple learning activities; older students can benefit from a review using the same activities.

The purpose of this series is to illustrate certain principles related to various concepts of aviation and space. More important, it is an opportunity for you to directly involve students in investigations and in making discoveries on their own.

You needn't be an "expert" in science to use this material. In fact, you shouldn't be expected to have all the correct answers to the questions presented in the material. Moreover, many of the activities are designed to include interdisciplinary skills and need not be used in sequence.

Each packet in the series forms a coherent program of instruction on a single topic: Non-powered Flight, Aerospace and the Environment, Space Exploration and Communications. Most of the tasks are introduced as a question. In order to answer the question, the students may want to first predict the solution. Then have them follow the activity instructions to arrive at an answer. This kind of student involvement may lead to other related questions generated by the teacher, other students, or suggested on the cards themselves.

Most of the activities utilize materials readily available from any given community and can be completed in the classroom. Others may require that you borrow some equipment from your science resource center or from a junior or senior high school in your district.

Please let us know your reactions to the materials and feel free to ask for more information related to aviation or space. We wish you success and many enjoyable experiences as you use these packets.

Written by Ms Debbie Williams and Ms Carol Hickson
Editorial Assistance by Mrs. Patricia Smithson
Illustrated by Mr. Harley A. Samford

NEWTON, THE FATHER OF EQUALITY OF FORCES

NL-1

About 250 years ago Sir Isaac Newton discovered that “for every action there is an equal and opposite reaction.” Test his law to see what happens.

Squeeze the two balloons together, pushing with only one of them. The “pusher” is compressed by the force of the push. The “pushed” is also compressed from pushing back with equal force. Can someone else tell which is the “pusher” and which is “pushed”?

MATERIALS:
2 balloons
inflated and tied

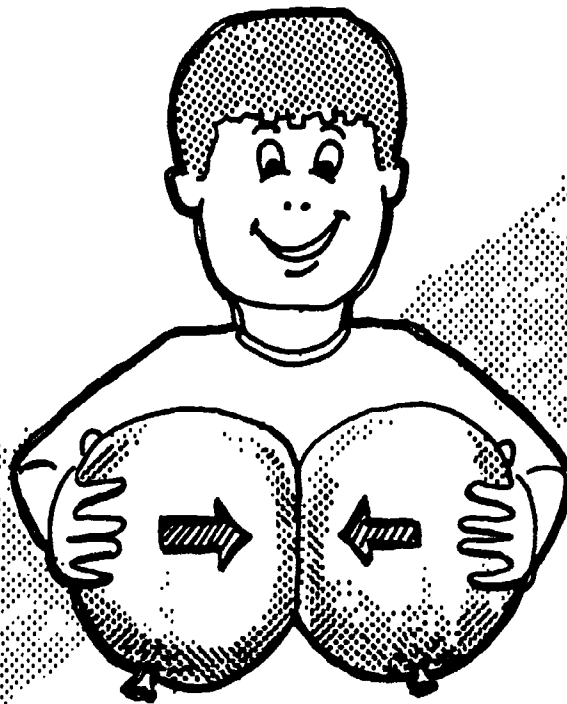

Pusher

Pushed

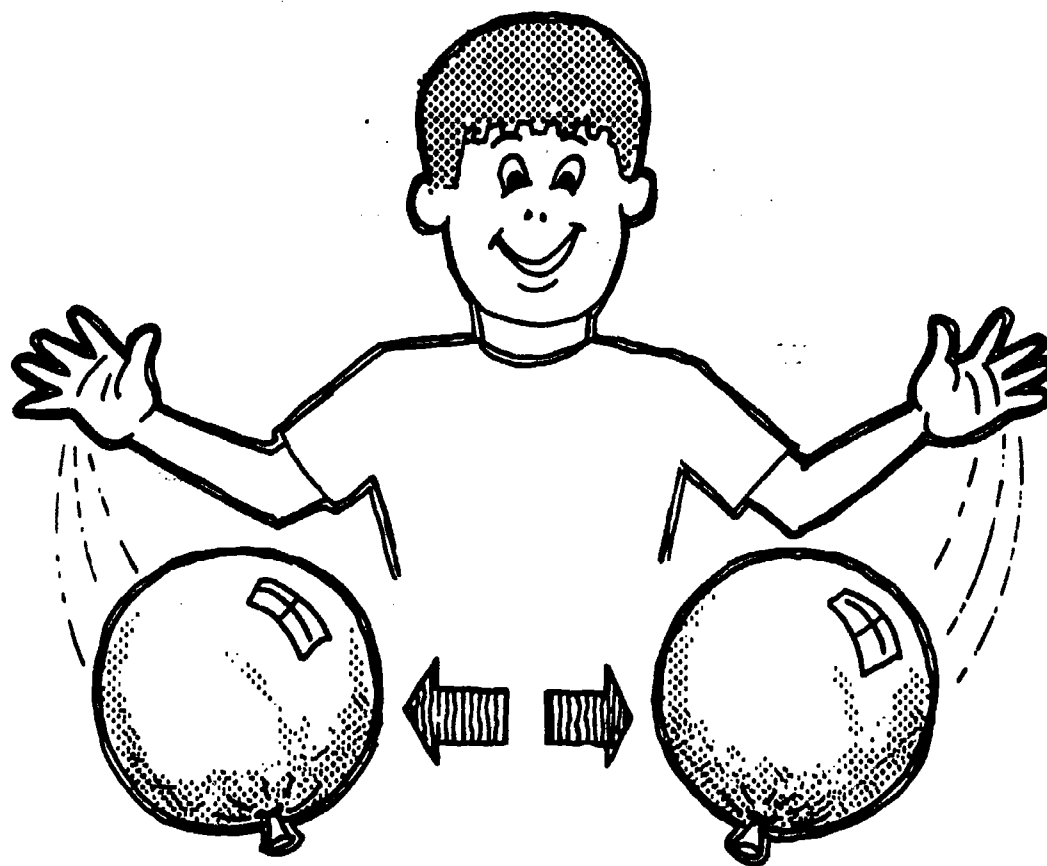

49

To prove further that they are pushing on each other equally, let go all at once. The balloons spring back into shape and push each other apart.



You have seen how equal force applied to the 2 balloons resulted in an equal opposing force. Now let's give Newton's law "for every action there is an equal and opposite reaction" another test.

MATERIALS:
Roller skates
Plastic jug of water or sand

Wearing roller skates, feet parallel, throw a plastic jug of water or sand to a friend 10 feet away. You push  forward, you roll  backward . . . Newton's law at work again.

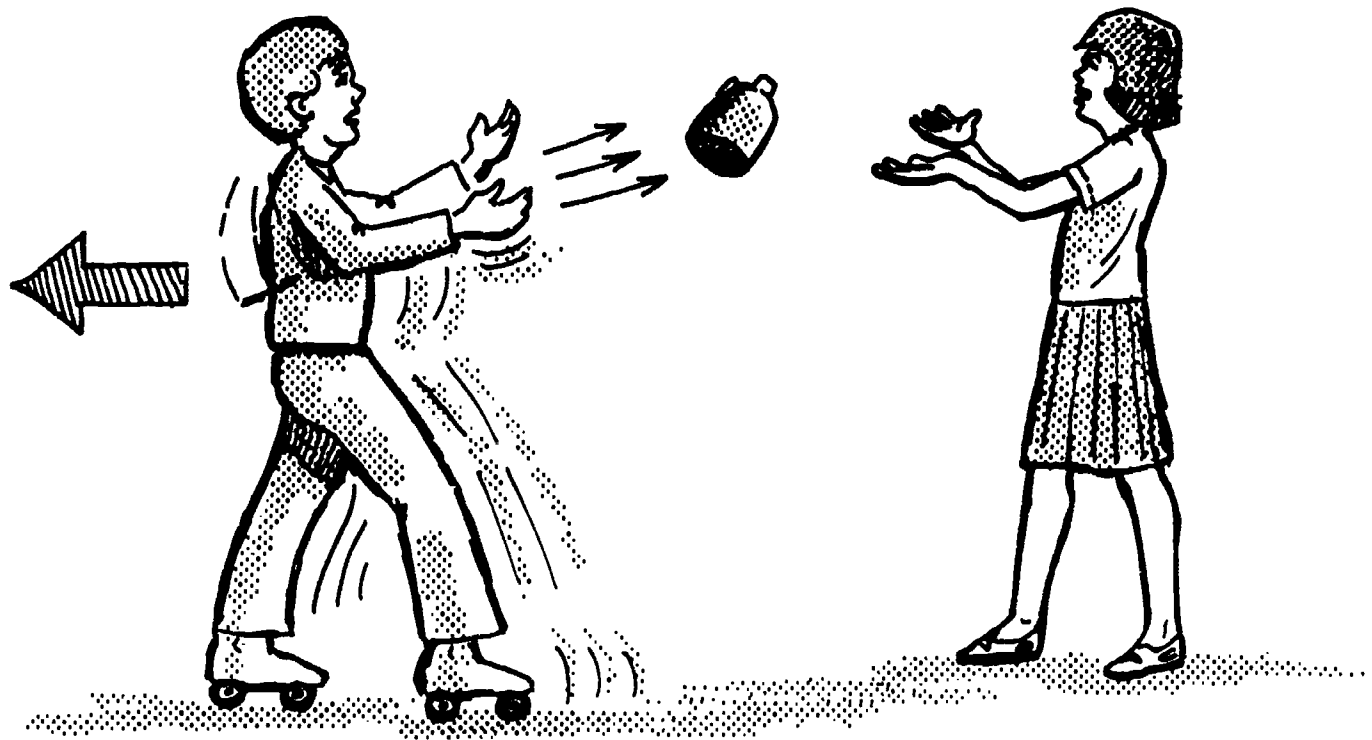

Here is another way you can test Newton's Third Law of Motion.

MATERIALS:

Tin Can
String
Nail

Water
Sink

Punch a hole in the side of the can near the bottom. Suspend the can from a string and hold it over a sink. Pour water into the can. As the water rushes out the hole at the bottom of the can, the can moves in the opposite direction.

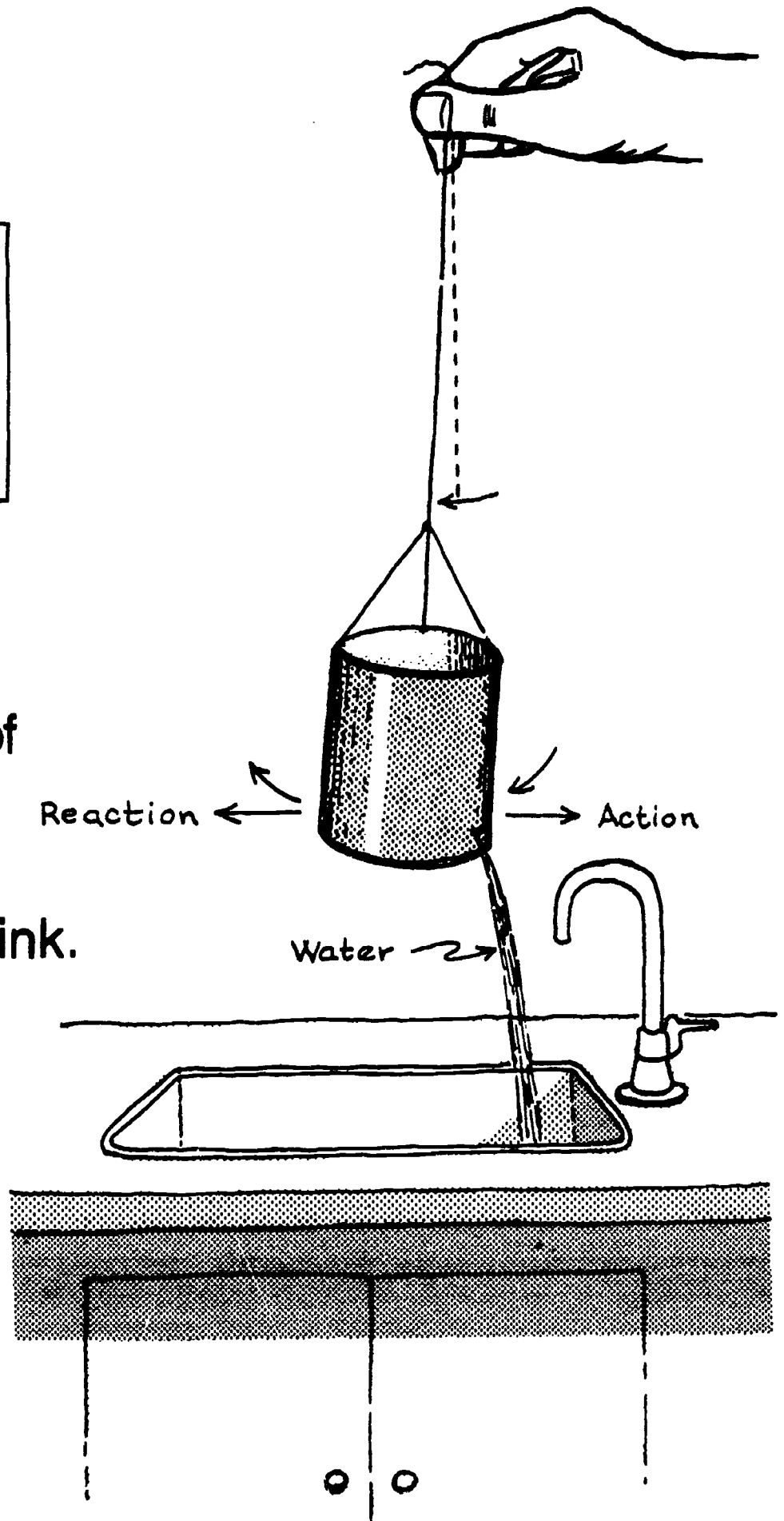

MATERIALS:
Large ball Strip of paper
2 Mason jar rings Marbles
Tin snips Ring to support ball

Cut off about 1/3 of the rim of the mason jar ring.
Replace it with a strip of paper. Secure the ball on a
large ring to keep it from moving.

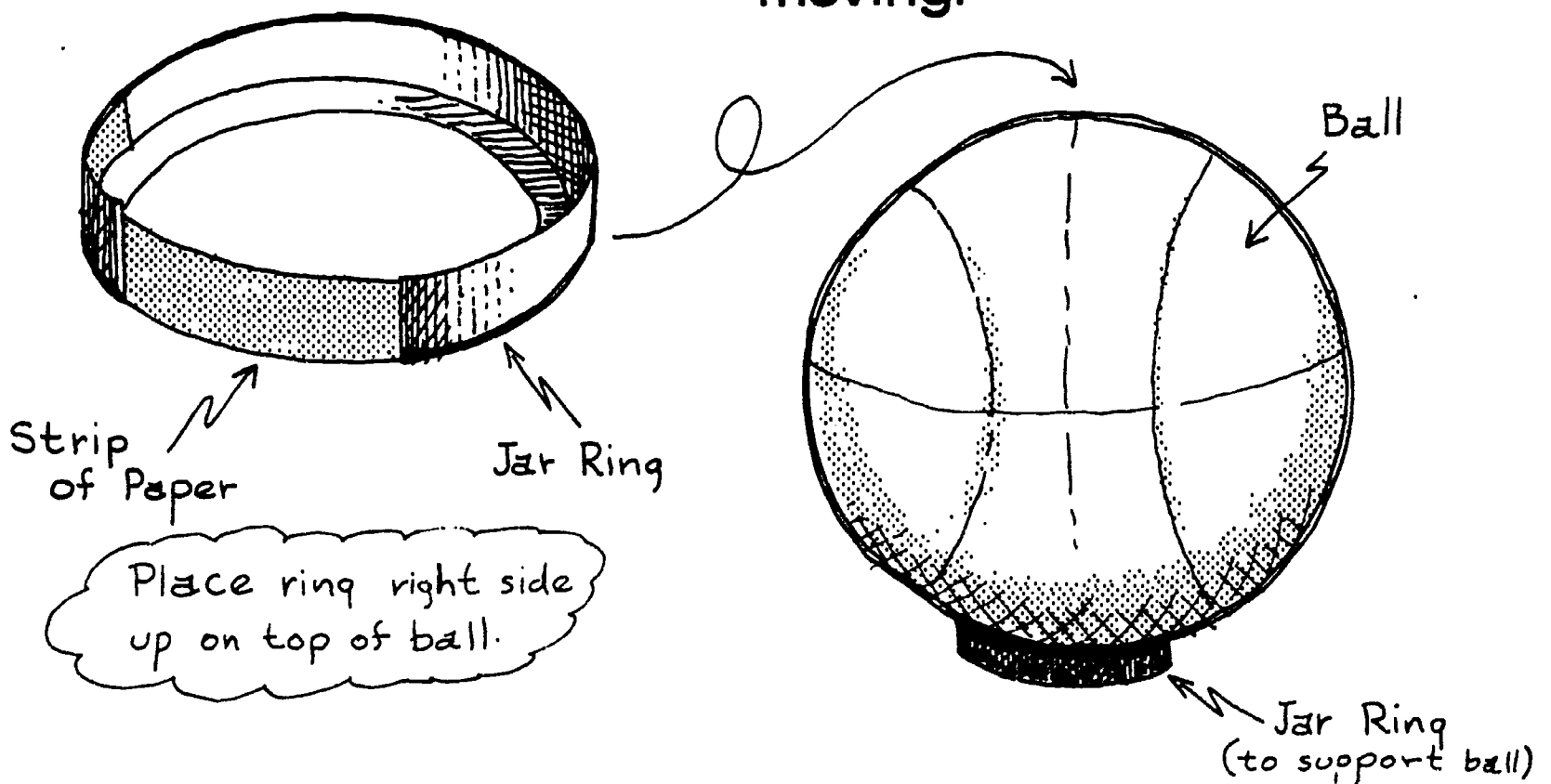

Place a ring on top and fill it with marbles. The marbles on the outside should fit under the edge of the lid so that the lid doesn't touch the ball. The ring does not roll because gravity is pulling each of the marbles down its own side of the ball, so the ring stays balanced. Carefully cut the paper. The marbles near the open end roll out reducing the force on that side. The ring then rolls away in the direction opposite the opening.

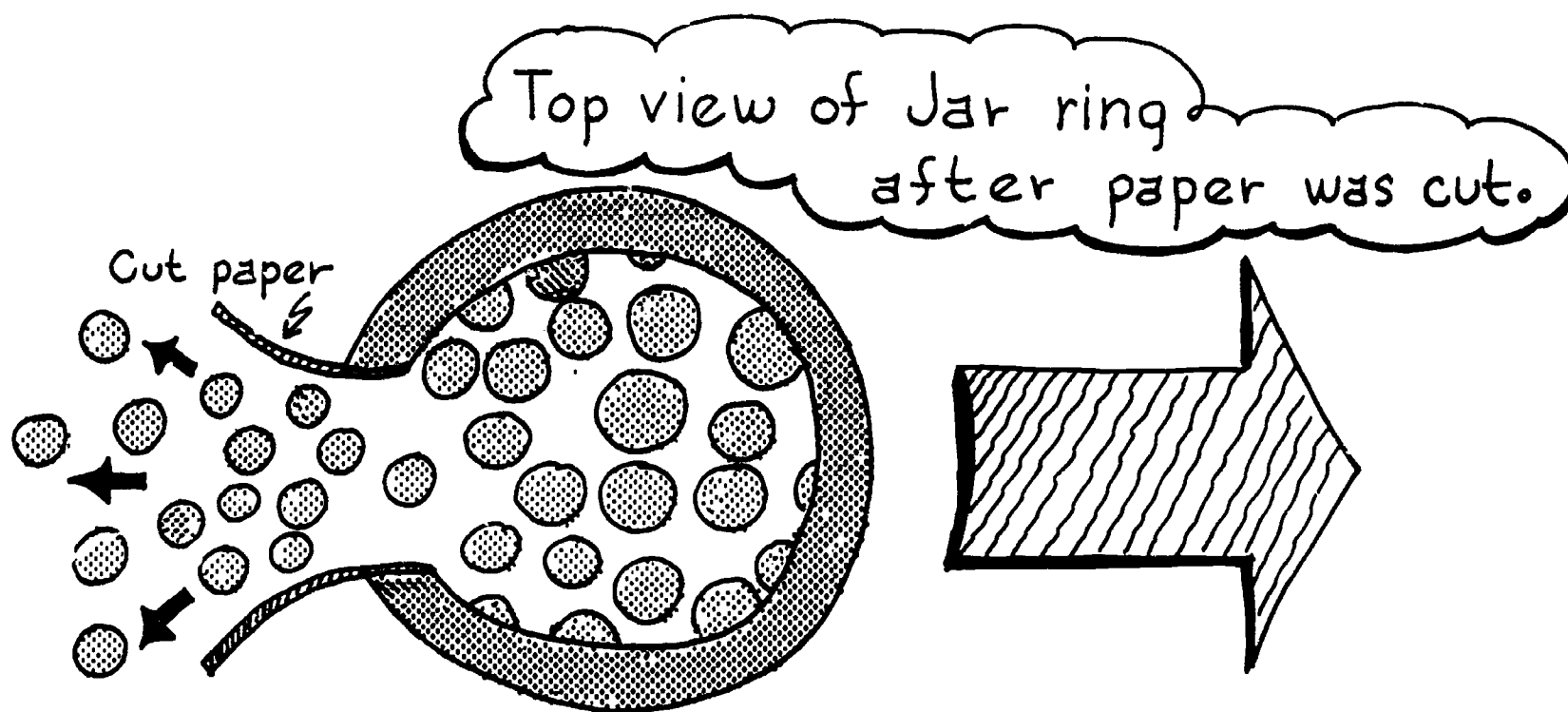
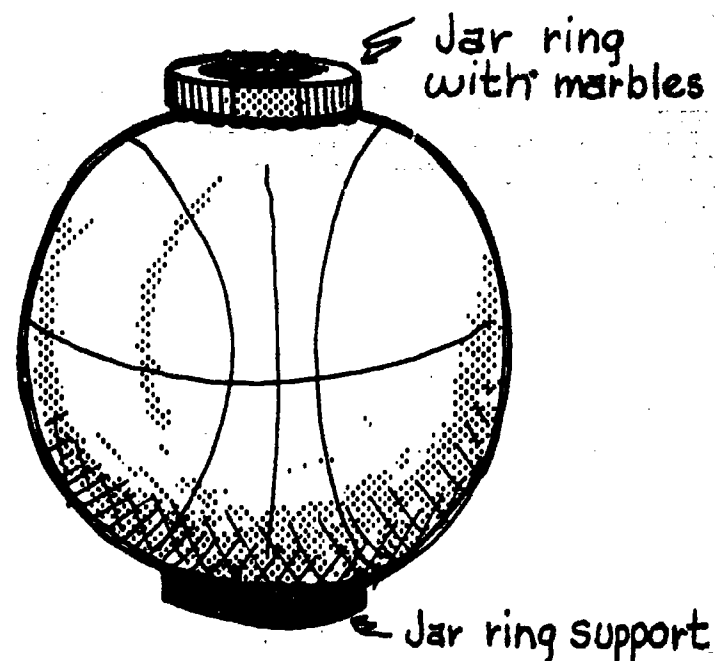

Another of Newton's laws says that an object at rest will remain at rest until acted upon by an outside force; and an object in motion will remain in motion, in a straight line at a steady speed until acted upon by an outside force. This is what he called inertia.

MATERIALS:
Stack of checkers
or quarters

Stack the checkers. Shoot one so it hits the bottom checker. When you flip the checker, you give it inertia. When it hits the bottom checker its inertia is transferred and the bottom checker moves with almost the same speed and inertia. The other checkers fall down because of the force of gravity.

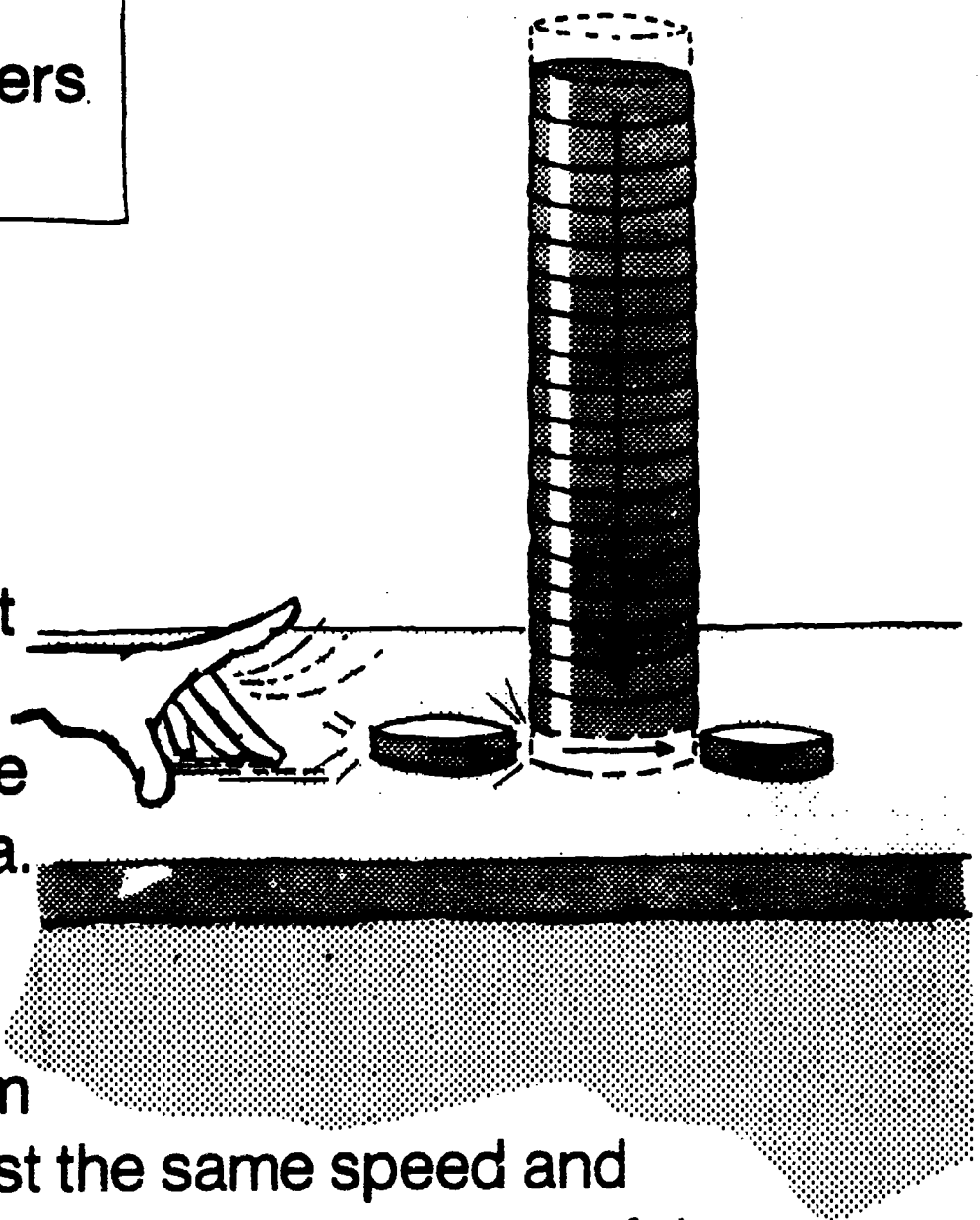

IS THE HAND REALLY QUICKER THAN THE EYE?

NL-6

Put inertia to the test.

MATERIALS:

Glass
Paper hoop
Coin

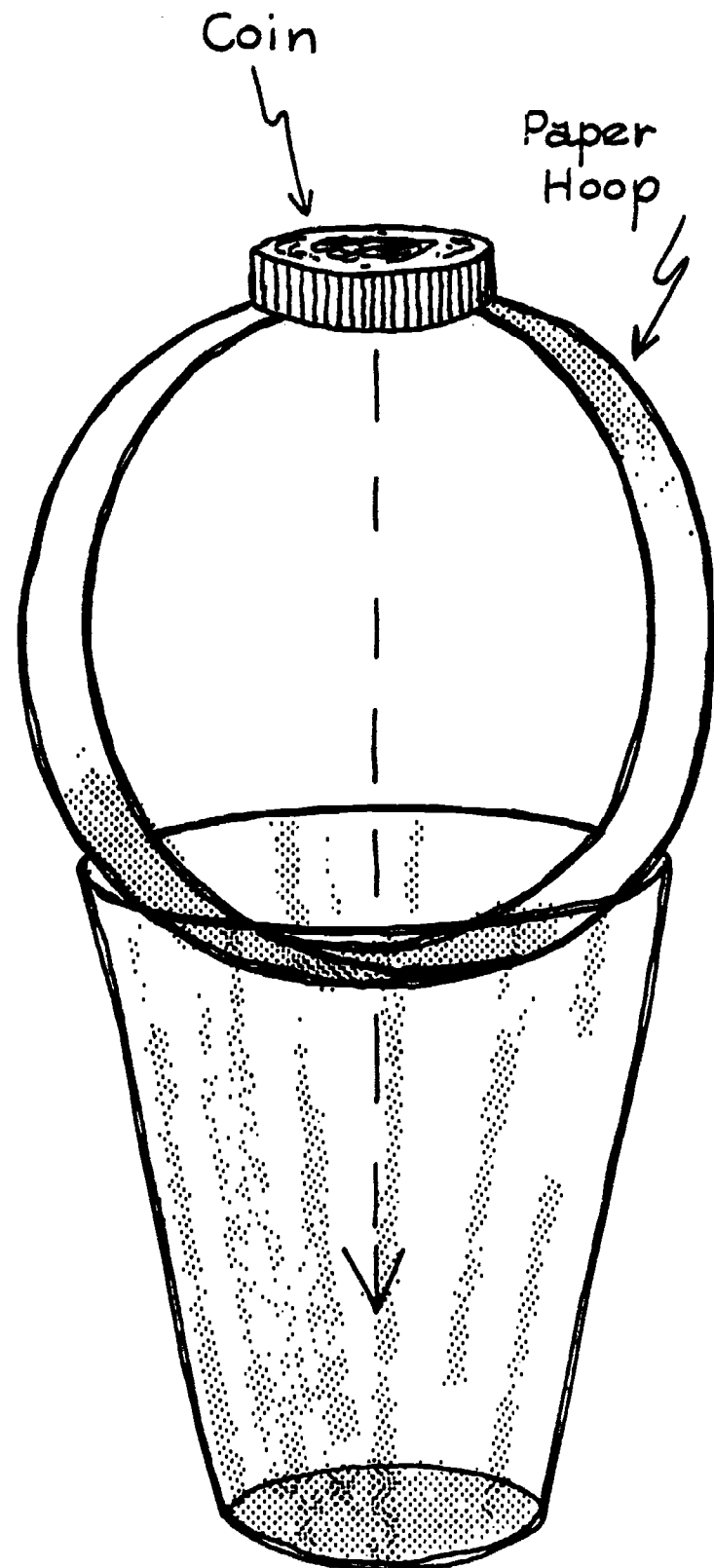

Place the coin on top of the paper hoop. Quickly pull the hoop away from the glass. The coin tends to remain at rest in mid air due to inertia. Then gravity takes over and causes the coin to fall into the cup.

WHY ARE ROCKETS SHAPED THE WAY THEY ARE?

R-1

(This activity should be done only with supervision of the teacher or other designated adult.)

Rockets are streamlined to allow them to move through the air easily. Streamlining also cuts down on the amount of heat produced on the skin of the rocket as its speed increases.

MATERIALS:

Round bottle, stiff paper, modeling clay, 3 inch candle, matches.

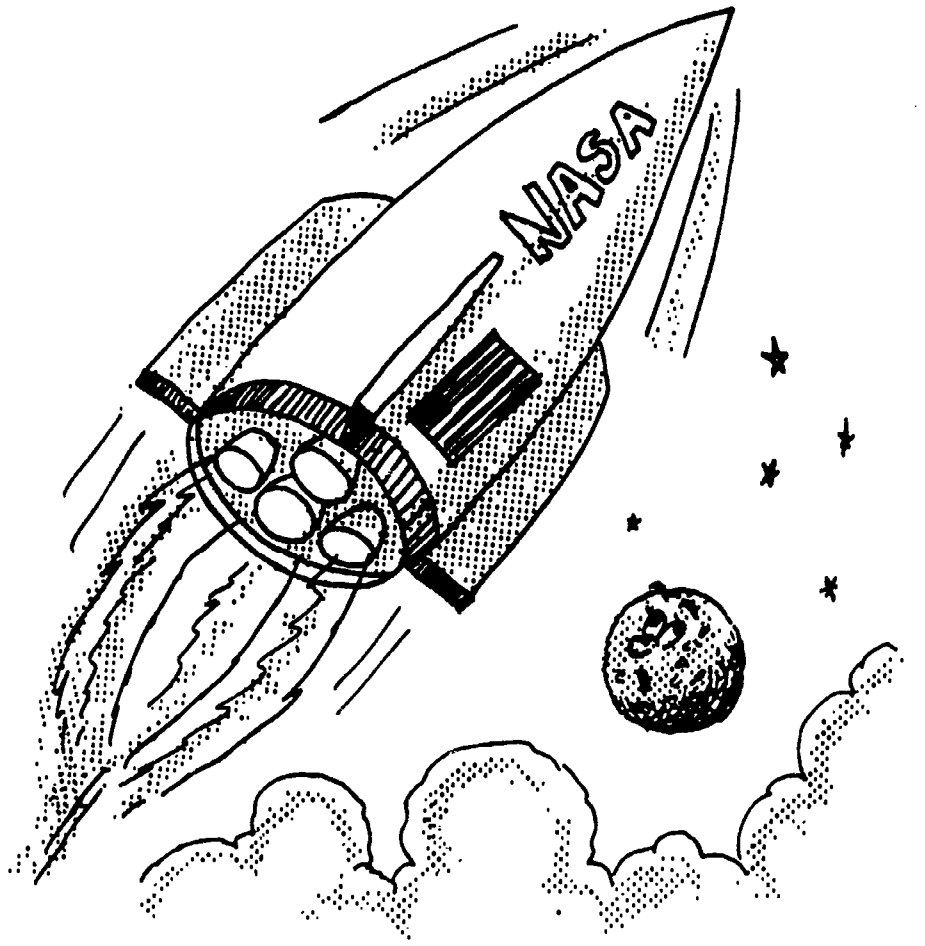

Place the bottle on a table. Place the lighted candle one inch behind the bottle. Blow on the front of the bottle. The flame moves toward the bottle.

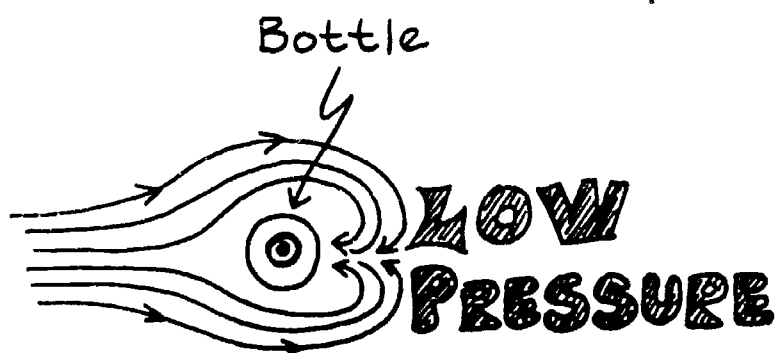
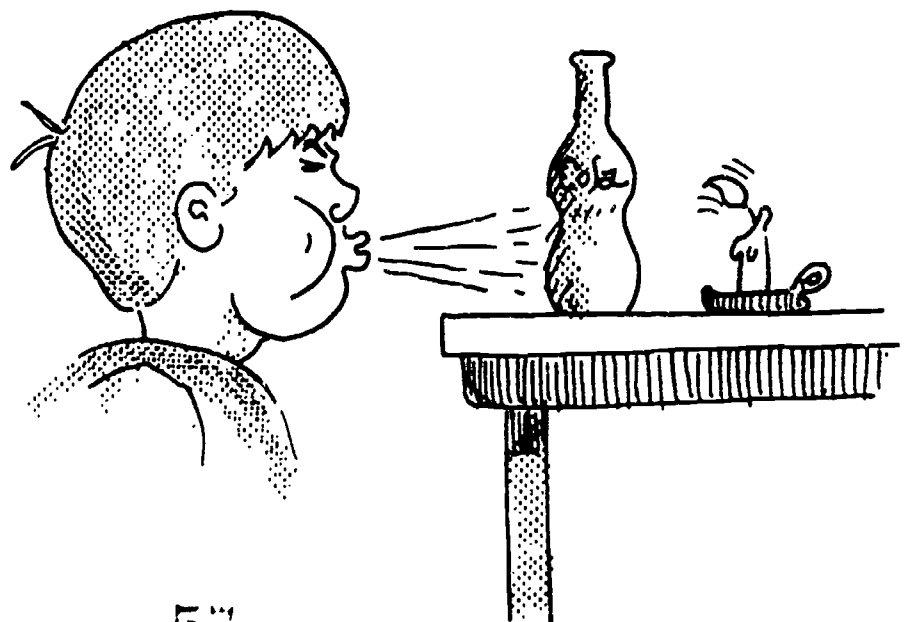

Cut the cardboard as wide as the bottle and half as high. Hold it in place on the table with modeling clay. Put the lighted candle behind the card and blow on the front of the card.

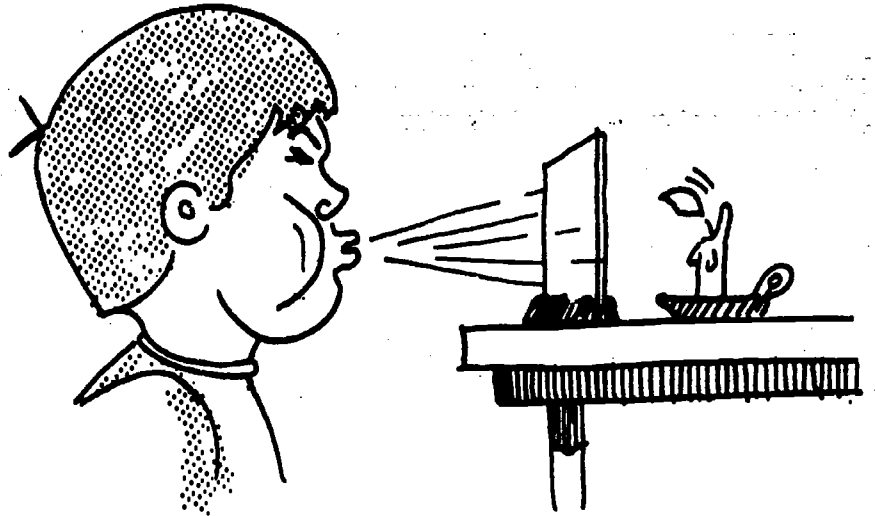

The flame moves toward the card.

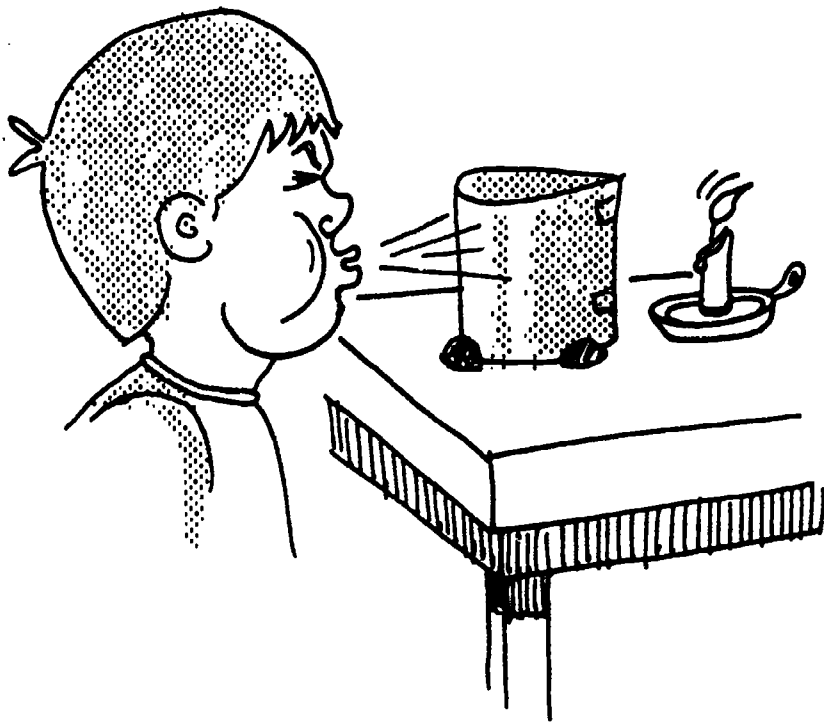

Now let's streamline! Wrap the stiff paper around the bottle. Cut it longer than the bottle is round. Tape the ends together so it looks like a teardrop. Place the candle behind the taped end and blow on the rounded end.

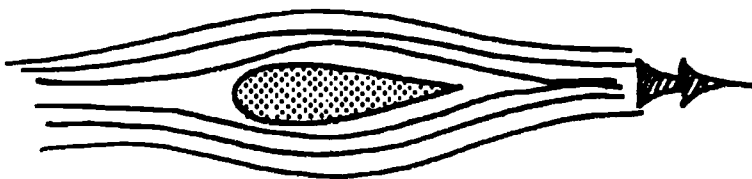

In which direction does the flame move? Why?

Rockets work like jets, but they do not need air. Therefore rockets work in outer space where jets cannot. Rockets carry their own supply of oxygen in the form of solid or liquid fuel. In a liquid fuel rocket, tanks of liquid fuel and liquid oxygen are pumped into the combustion chamber and ignited. This causes the liquids to expand, become gas, and build pressure rapidly. As the hot gases escape through the nozzle, the rocket shoots ahead.

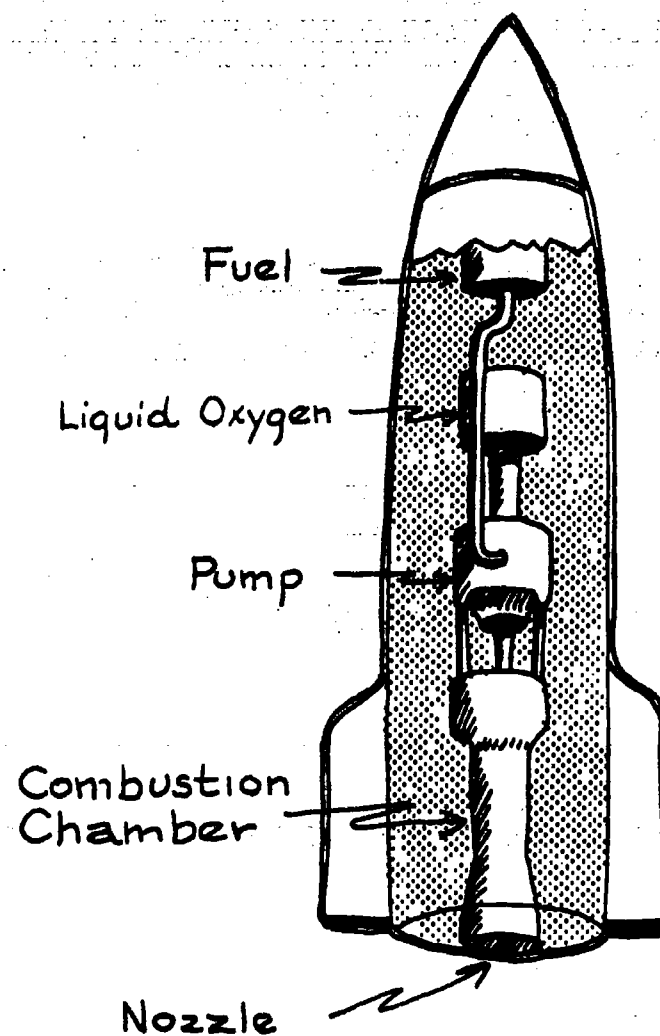

MATERIALS:

Bottle and cork
Baking soda
Tissue paper



Vinegar
Vaseline
6 (or more)
round pencils

Proceed outdoors!

Lubricate the bottle top and cork with vaseline. Fill bottle halfway with a mixture of 50% water and 50% vinegar (fuel). Put two teaspoons of baking soda (oxidizer) in tissue and twist the ends.  Slip the baking soda into the bottle and put the cork in place. Place the bottle on its side on the pencils.

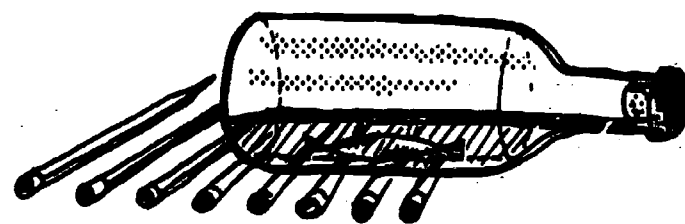
When the baking soda mixes with the vinegar, a chemical reaction takes place releasing a large quantity of



rapidly moving expanding gases. Then . . . The cork etc. — shoot  forward, the bottle rolls  in the opposite direction.

The amount of push that a rocket has is called thrust. The push of a balloon can be measured when the balloon is traveling on a string from floor to ceiling. Nuts, bolts, or washers can be used to measure the push of the balloon.

MATERIALS:

Balloon Dixie cup
Straw Nuts, bolts
String Tape

Experiment 1:

Thread a piece of string through a straw. Attach the ends of the string to the ceiling and the floor. Tape an inflated balloon to the straw. Release the neck of the balloon. How fast do the balloon and straw travel up the string?

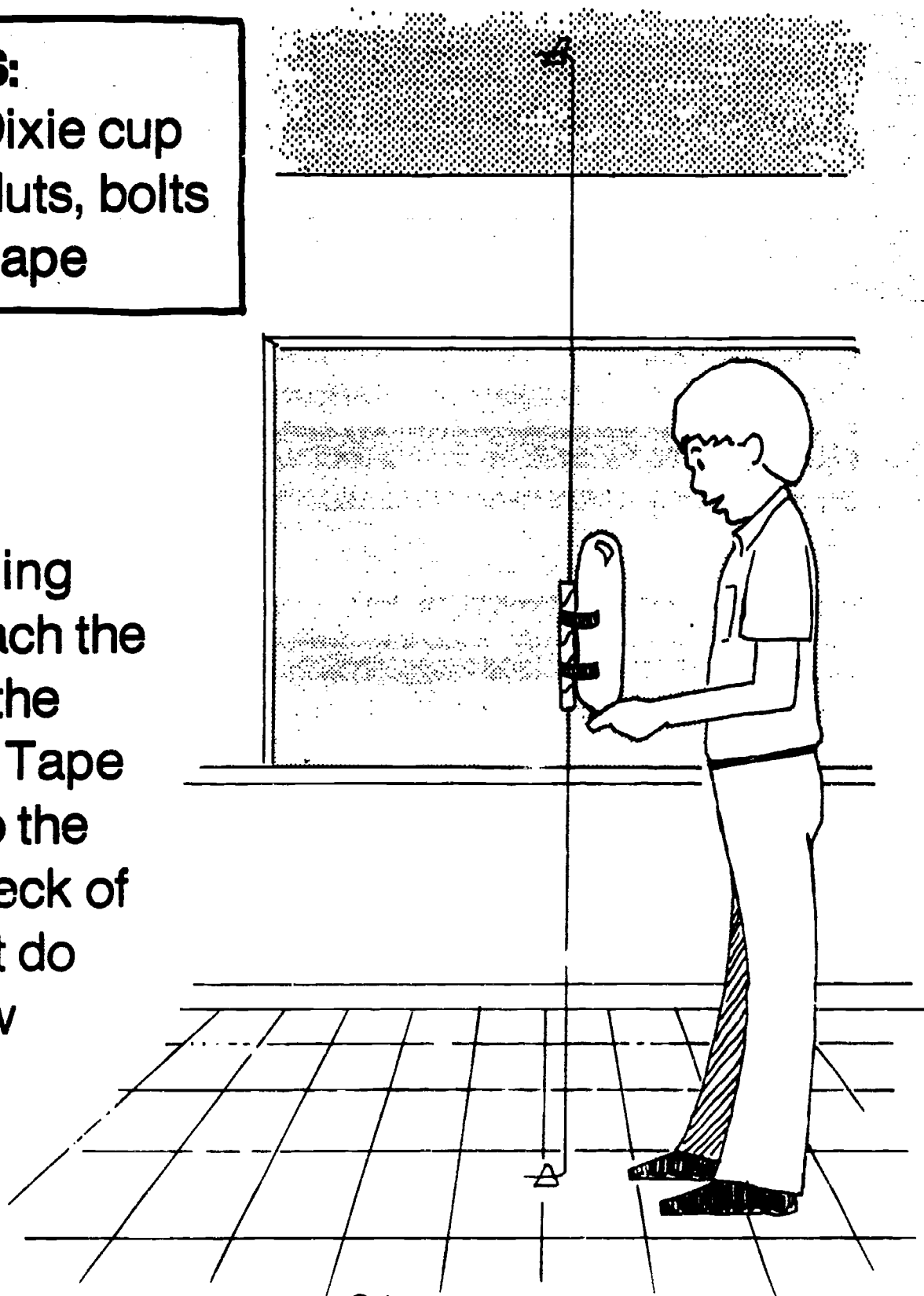

Experiment 2:

Attach 3 strings to a Dixie cup. Tape the strings to the inflated balloon so that the cup is suspended like a gondola beneath it. Release the neck of the balloon. How fast did the balloon, cup and straw travel up the string?

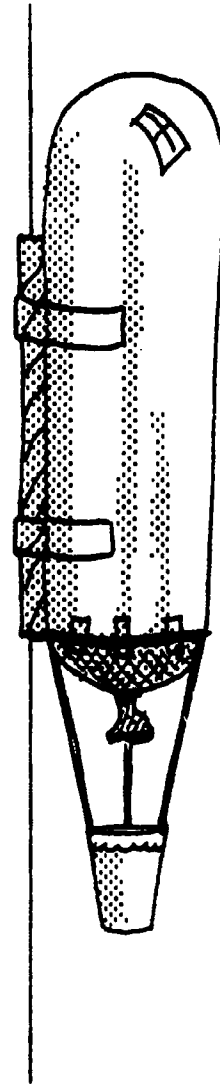
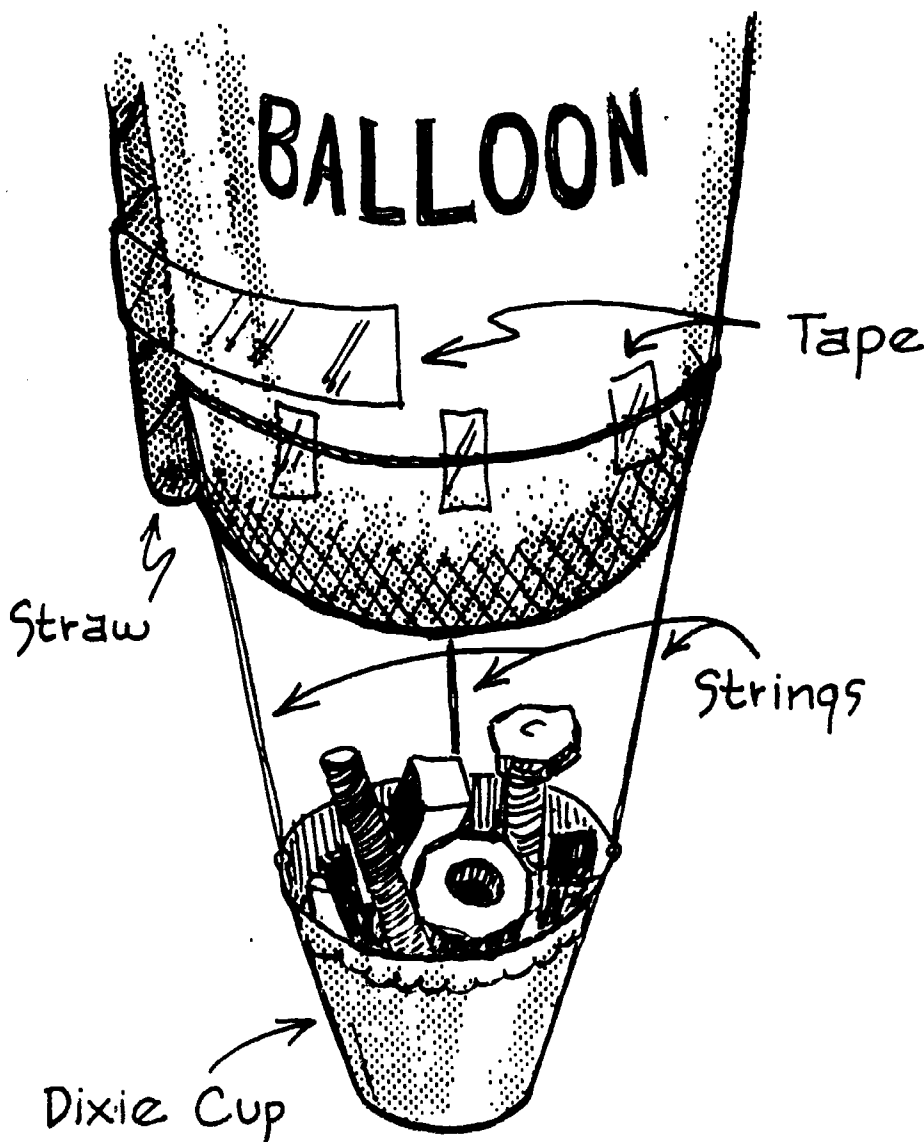

Experiment 3:

Add some weights (nuts, bolts) to the cup and repeat the experiment. How fast did the balloon, cup and straw travel up the string?

How much weight can the balloon lift?

The working model of a rocket shown here is most easily assembled if you have access to chemistry lab supplies. It can also be constructed from other readily available materials if you use your imagination.

MATERIALS:

- A sidearm test tube stand with bar
- A long piece of rubber tubing
- A cork or stopper with glass tube in it
- A sidearm test tube – Thread

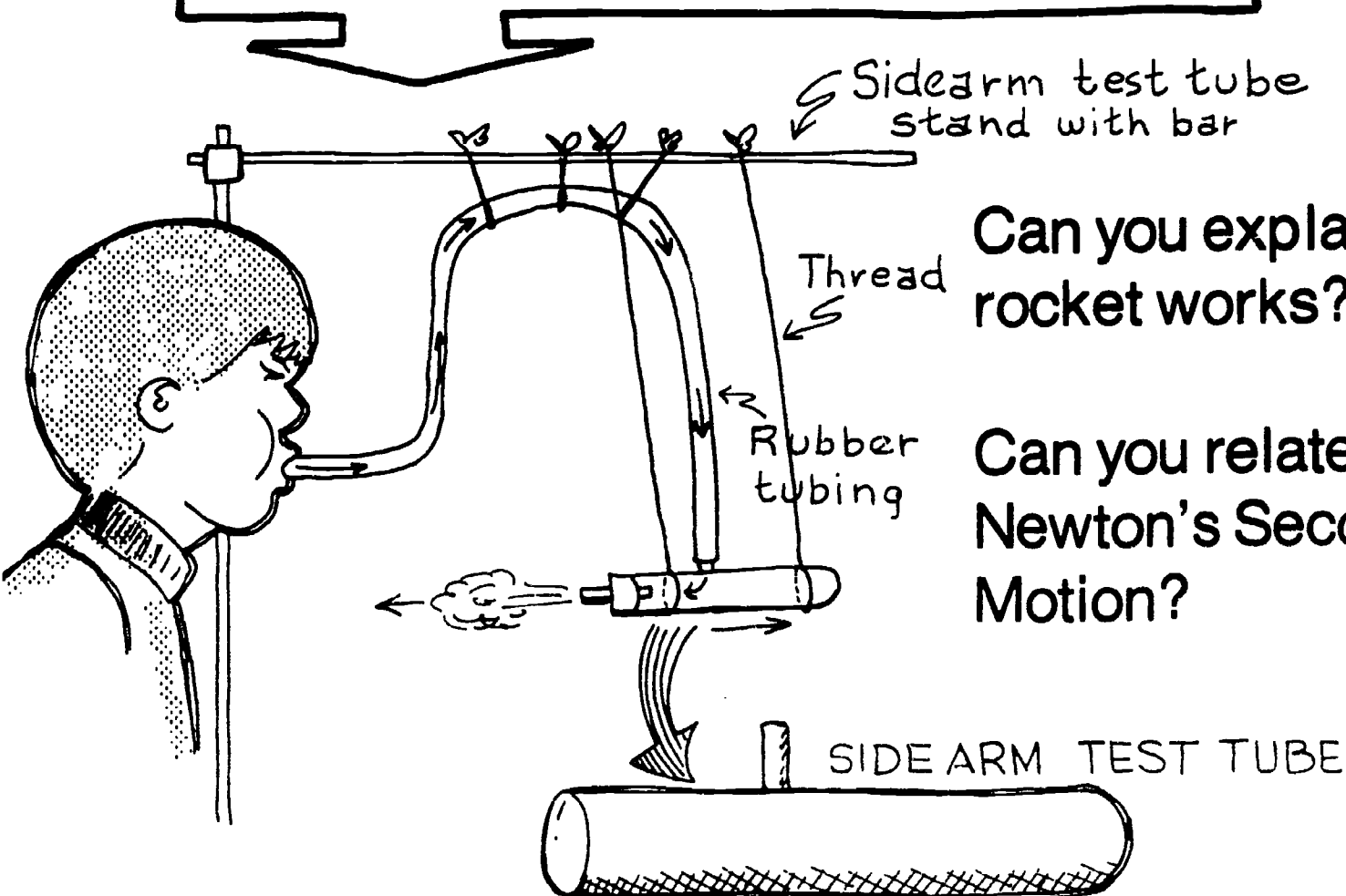

Can you explain how this rocket works?

Can you relate this to Newton's Second Law of Motion?

MATERIALS:

Small plastic straw
Larger plastic straw
Plastic squeeze bottle
(with a screw cap)
Thin cardboard
Glue, scissors, clay

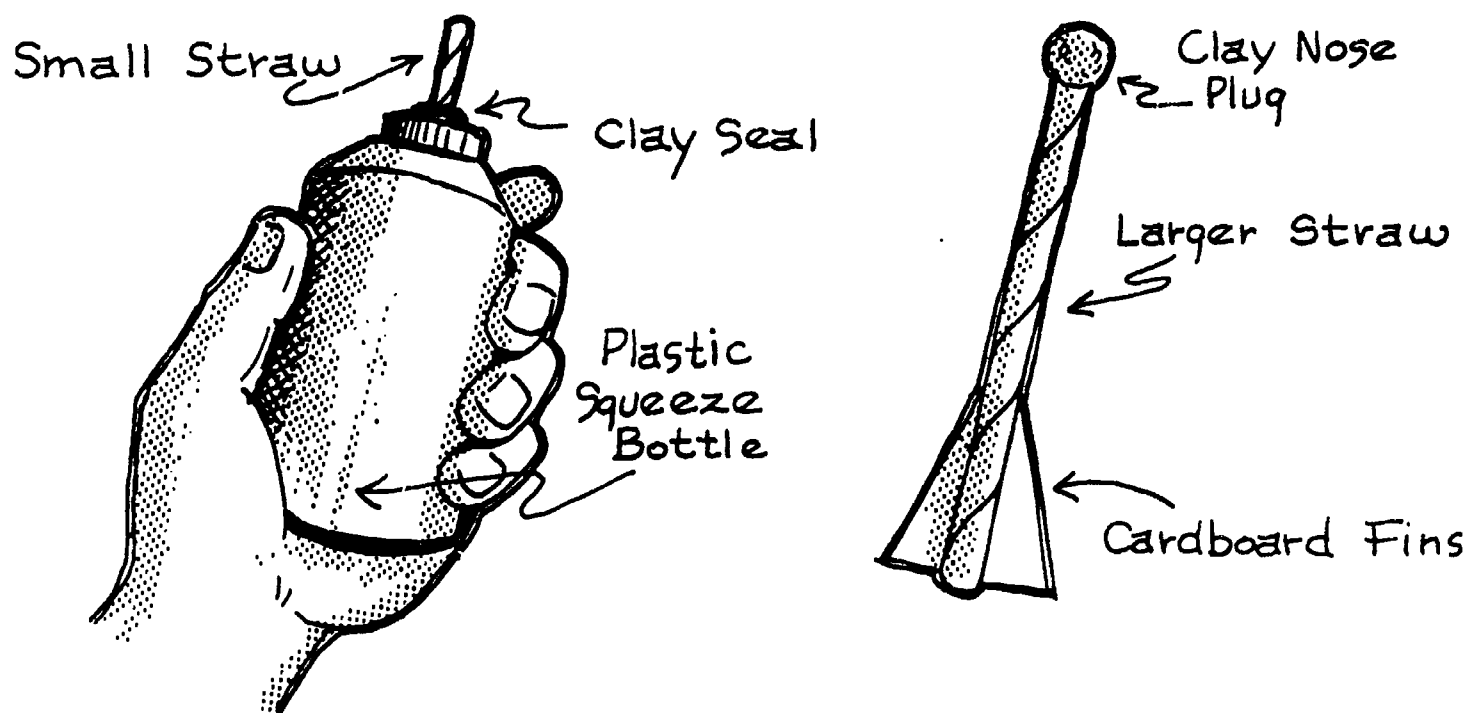

Make a hole in the bottle cap just wide enough to slide the small straw through. Leave about 4 inches sticking out of the cap. Seal with clay. Cut the larger straw to about 4 inches in length. Seal one end with a clay "nose cone." Use the cardboard to cut fins for your straw rocket. Glue them to the unplugged end.

Slide the straw “rocket” over the smaller straw “launcher.” Give the plastic bottle a quick, strong squeeze.

What happens? Why?

Can you compare this to suddenly letting go of an air filled balloon? Or, to pulling the trigger on a BB air rifle? What is meant by compressed air? Can you think of some industrial uses of compressed air?

The path of a speeding spaceship can be changed by the gravitational force of a planet. The gravitational pull of the planet can also cause the spaceship to speed up. You can make a working model to see how this happens.

MATERIALS:

A square box

A piece of plastic

Lead sinker or weight

1" x 12" strip of heavy cardboard

Marbles

Tape

Fold cardboard along its length to make a launcher for the "spaceship" marble.

Stretch the plastic tightly over the opening of the box and tape in place.

Put planet "sinker" in the middle of the sheet of plastic.

Launch a marble from any edge of the box. What happens?

Tape one end of the launcher to one side of the box. What happens to the speed of the marble as you raise or lower the launcher? What happens to the path or orbit of the marble as the speed increases or decreases?

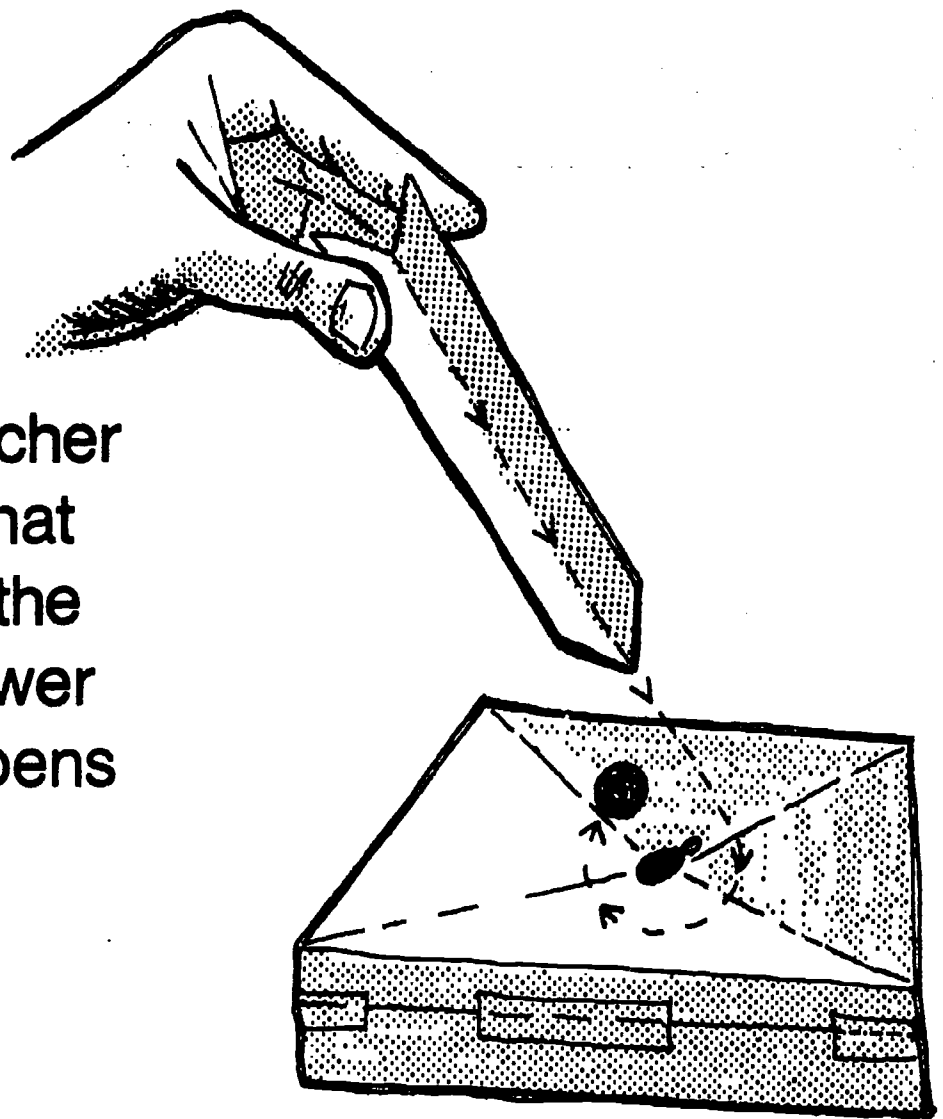

Do you think scientists could use the gravitational pull of various planets to help guide a spaceship's journey?

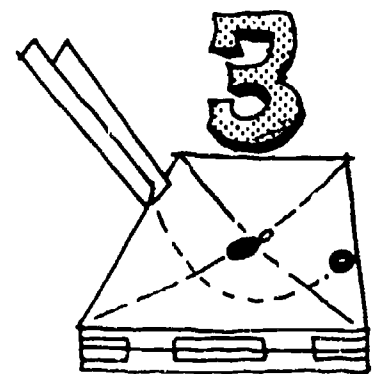
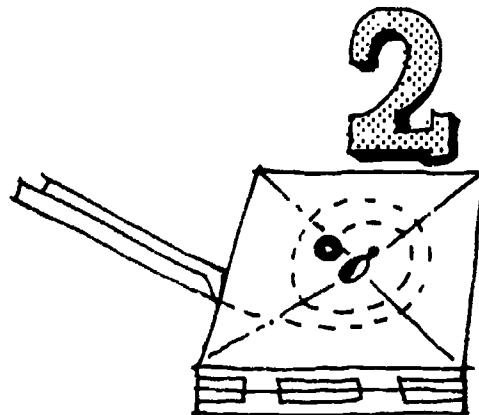
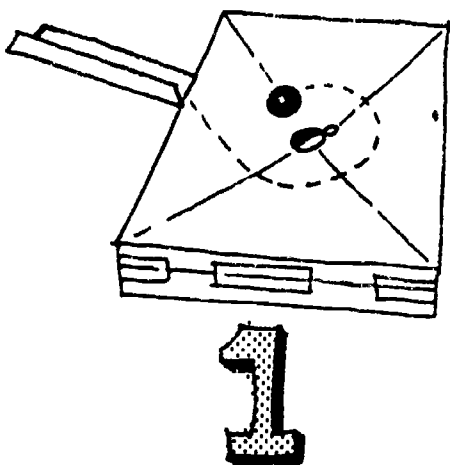

What happens to the acceleration of gravity if you throw an object in a horizontal direction? Will the object take longer to reach the ground than an object merely dropped from the same height?

MATERIALS:

A stick — A smooth board

A small nail — 2 coins (similar)

Make a hole near one end of the stick and pivot the stick to the board by driving a slightly smaller nail through the hole. Place the board at the edge of a table. Position the stick and coins as shown, then swing the stick sharply to throw the coins off.

What happens? Were you surprised to learn that the rate an object falls toward Earth is not affected by its forward motion?

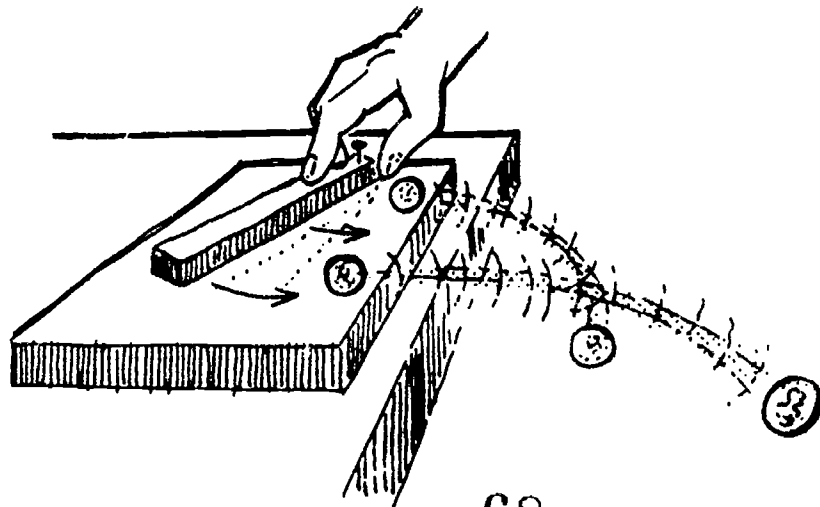

The faster an object moves in a horizontal direction, the farther it is able to go before gravity pulls it back to Earth's surface.

Can you relate this to escape velocity of space vehicles or satellites?

When a space traveler experiences “weightlessness,” has gravity been suspended so that he really has no weight?

The pull of gravity is present throughout the universe, but during “weightlessness,” man and objects are falling freely at the same rate. They seem to have no weight because there is nothing in the way to oppose their fall. The following experiment will help you understand how free fall creates the illusion of “weightlessness.”

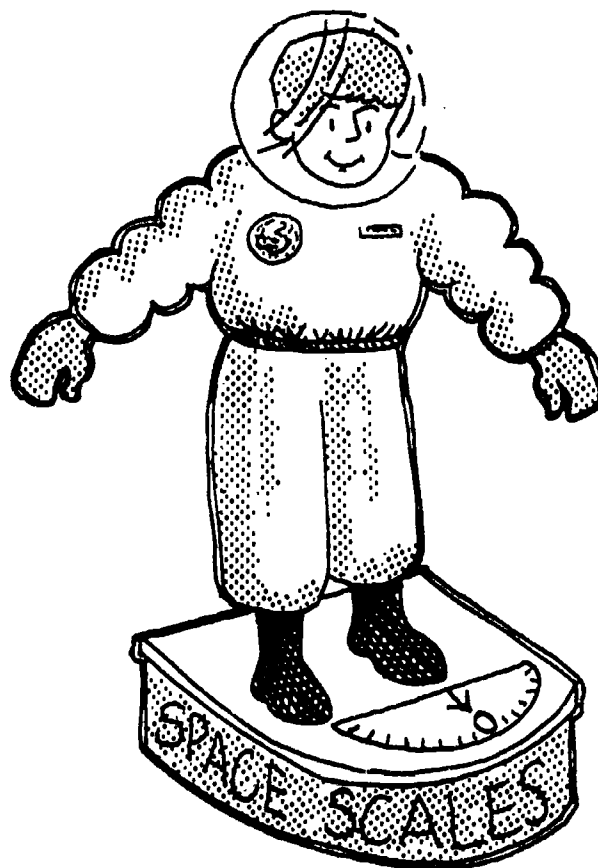

MATERIALS:

Plastic cup
Loop of string
Wooden ball or
a metal nut or
washer

Suspend the plastic cup from a loop of string. Hang the wooden ball, metal nut, or washer from a shorter string held (but not tied) at the top of the loop

First place the plastic cup on a table and release the ball from above the cup. Next, stand on a stool or chair, hold the cup and ball high, then drop them

together. The ball will fall as fast as before but this time the cup is falling away from it with equal speed. As long as they are falling the ball will hang above the cup.

The ball, with nothing to press against it, is temporarily weightless.

This is the state of a space vehicle when it is coasting through space without power.



In a weightless space vehicle there would be no up or down. An astronaut could not walk because his feet would not press against anything. Loose objects would float around the cabin. A practical way to solve weightless problems would be to provide artificial gravity by giving the space vehicle or space station a spin.

Let's find out how rotation can produce artificial gravity.

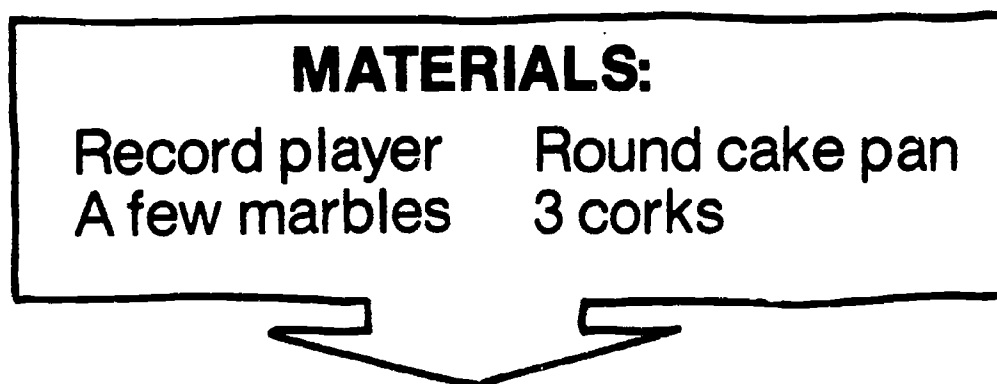

Use the corks to raise the cake pan above the turntable spindle. Center the pan carefully. Arrange the marbles in the pan at random.

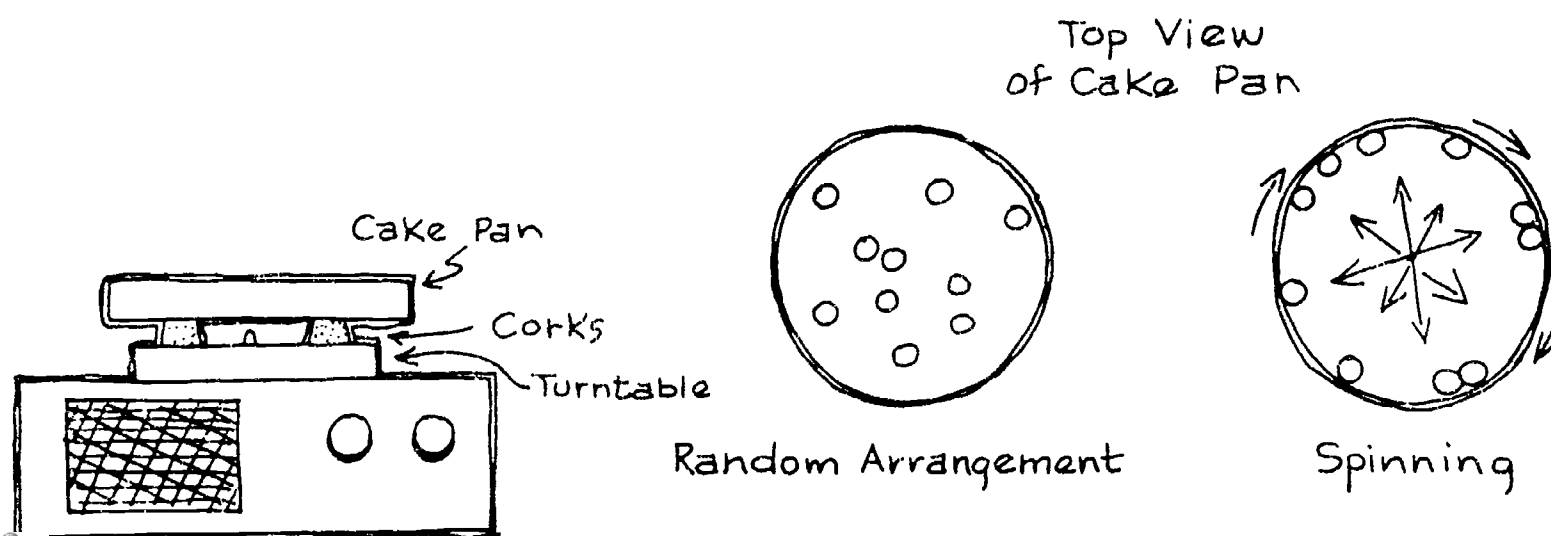

Start the turntable spinning. If the pan turns fast enough, the straight ahead effect of inertia will win and the marbles will continue in a forward motion until they are stopped by the side of the pan. Man, or unattached objects would be moved to the floor of a spinning space vehicle in this same manner.

Stop the spin, and like men under free fall, the marbles wander again. A strange property of artificial gravity is that it weakens as you move toward the center, finally becoming zero.

Experiment by placing the marbles at different distances from the center of the pan. Try experimenting with various speeds of the turntable also.

MATERIALS:

Marble
Pencil
Paper

Roll the marble off a table.
Have someone draw the
path or trajectory as it
leaves the table.
Repeat the process
using greater force
each time.

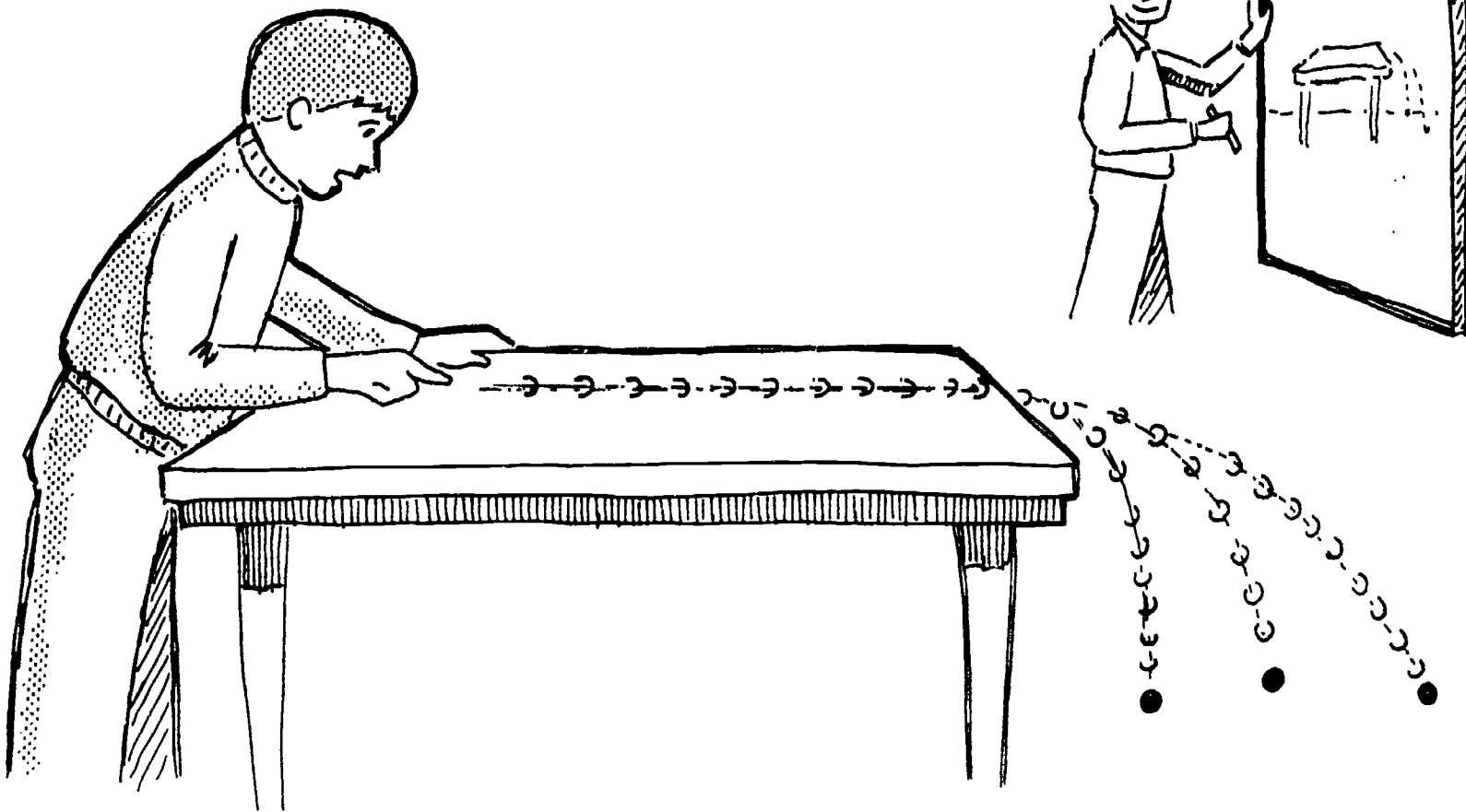

Compare the trajectories. What conclusion do you reach about speed (velocity) and the width of the trajectory? Write your conclusion underneath your trajectory drawings.

MATERIALS:

Spool
String
Washers
Nylon stocking
Small rubber ball

Cut a piece of nylon to put around the rubber ball. Tie one end of a string around the nylon and put the other end through the spool and attach a

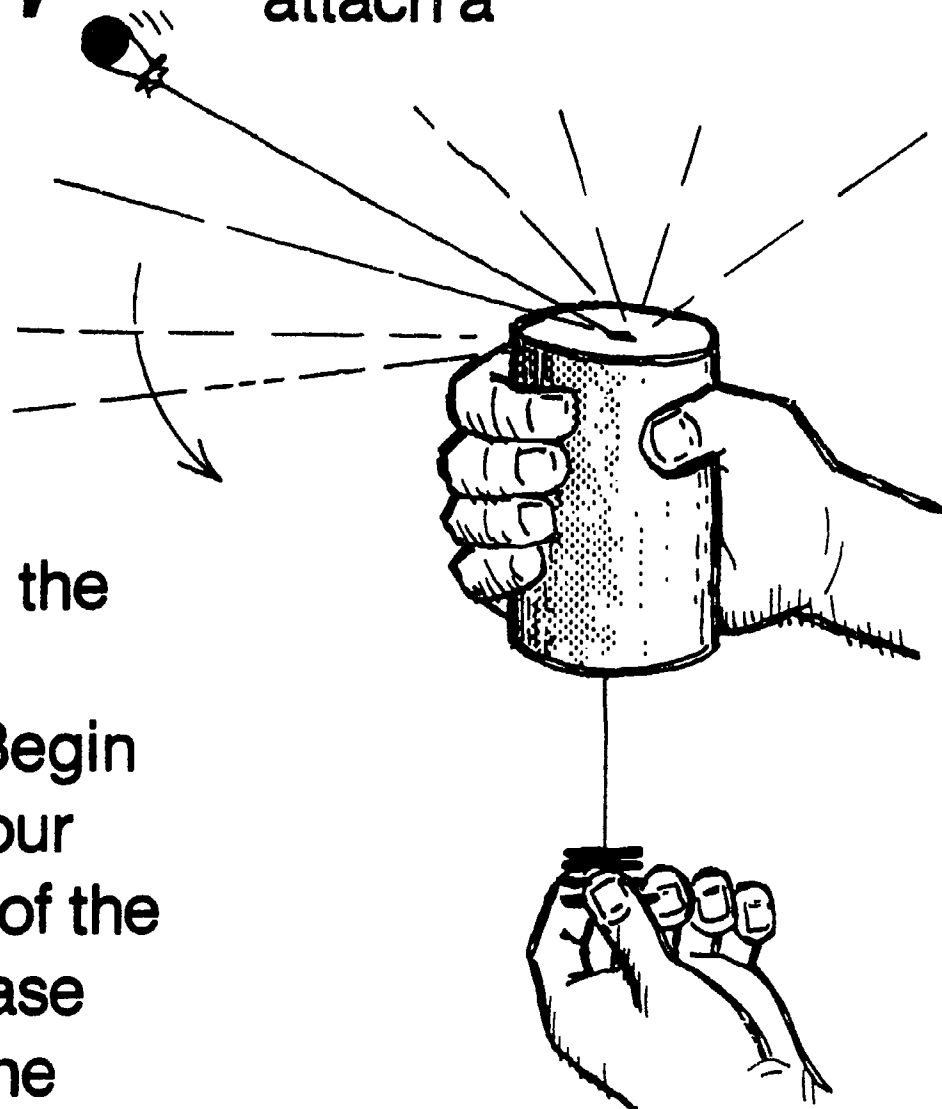

few washers to it. Hold the spool in one hand, the washers in the other. Begin to whirl the ball over your head. Gradually let go of the washers. As you increase the speed of the ball, the washers move closer to the spool. As you slow down, the washers begin to fall away from the spool. While the ball is whirling, have someone cut the string between the washers and the spool. The ball will fly away from the spool in a straight line due to its inertia.

The ball is held in orbit around the spool by the string. This corresponds to the force of gravity on a satellite, which causes an inward pull. The outward pull of the ball is called centrifugal force. When these forces are equal, the ball remains in an orbit, without falling into or flying away from the spool.

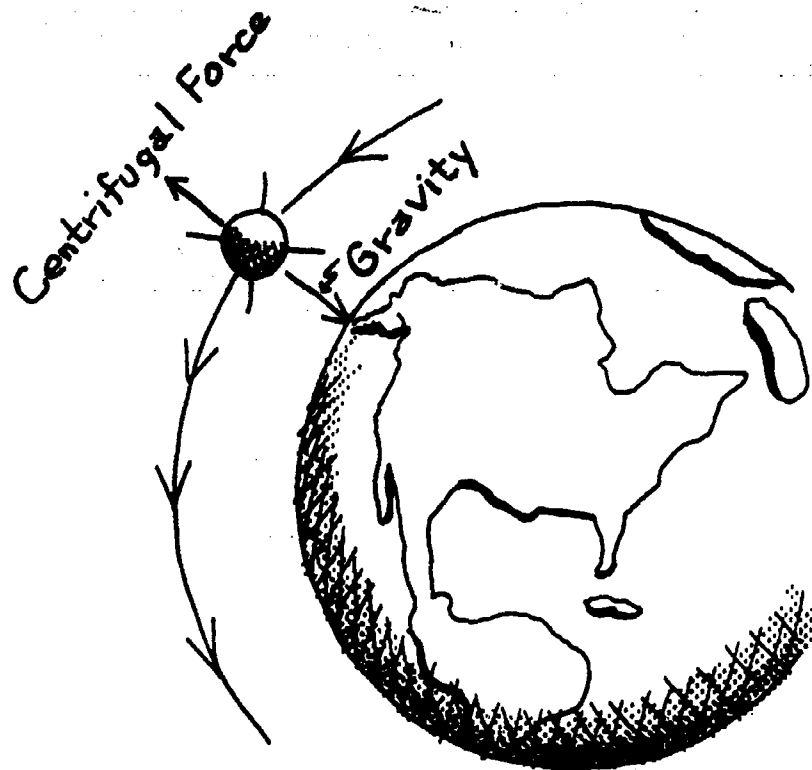

MATERIALS:

- An aluminum foil cup
- A needle – A cork or eraser
- A clear plastic container
- A horseshoe magnet
- A piece of string (1 ft. long)

Satellites are sometimes given a spin to keep their axes pointing in the same direction.

Balance the aluminum foil cup on the point of the needle held upright in the cork or eraser. Then enclose it completely in the clear plastic container. Tie the horseshoe magnet to the string and suspend it above the container.

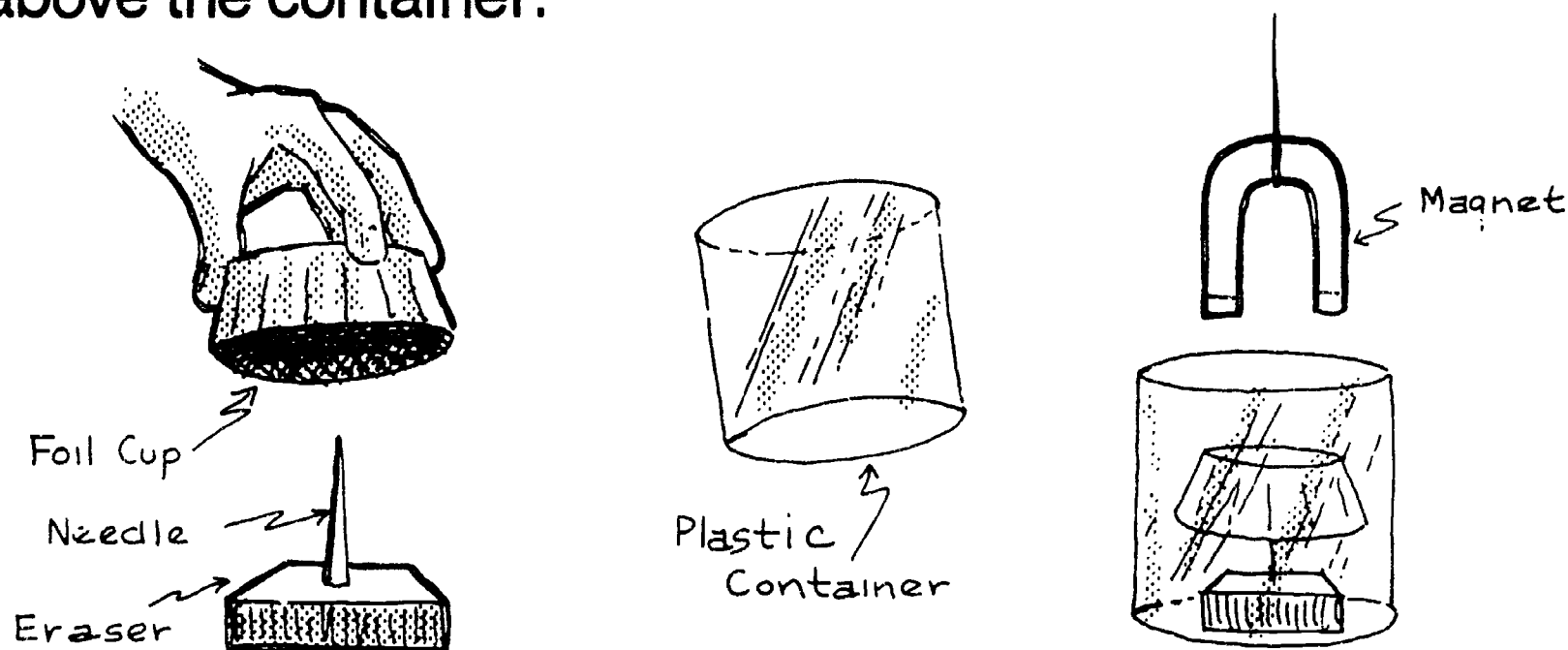

Twist the magnet several dozen times and let it go. The cup will spin in the direction of the whirling magnet. Spin the magnet in the other direction and the cup will also spin in that direction. Although the magnet will not attract aluminum, moving near the cup the spinning magnet generates stray electrical currents. The currents create magnetic fields which are attracted by the magnet and cause the cup to be dragged around as the magnet spins.

Earth's magnetism gradually slows down the spin of artificial satellites. Demonstrate this "holding-back" effect by spinning your cup and then resting the magnet on the container. What happens?

Investigate the mechanics of the speedometer on your family auto, or the kilowatt-hour meter in your home. How do they relate to your experiment?

Let's find out what space scientists mean by "escape velocity."

MATERIALS:

A cardboard trough shaped like a flattened **M**

Two supports of equal size (books, blocks, boxes)

A piece of glass (like a window pane)

A steel ball bearing

A strong bar magnet

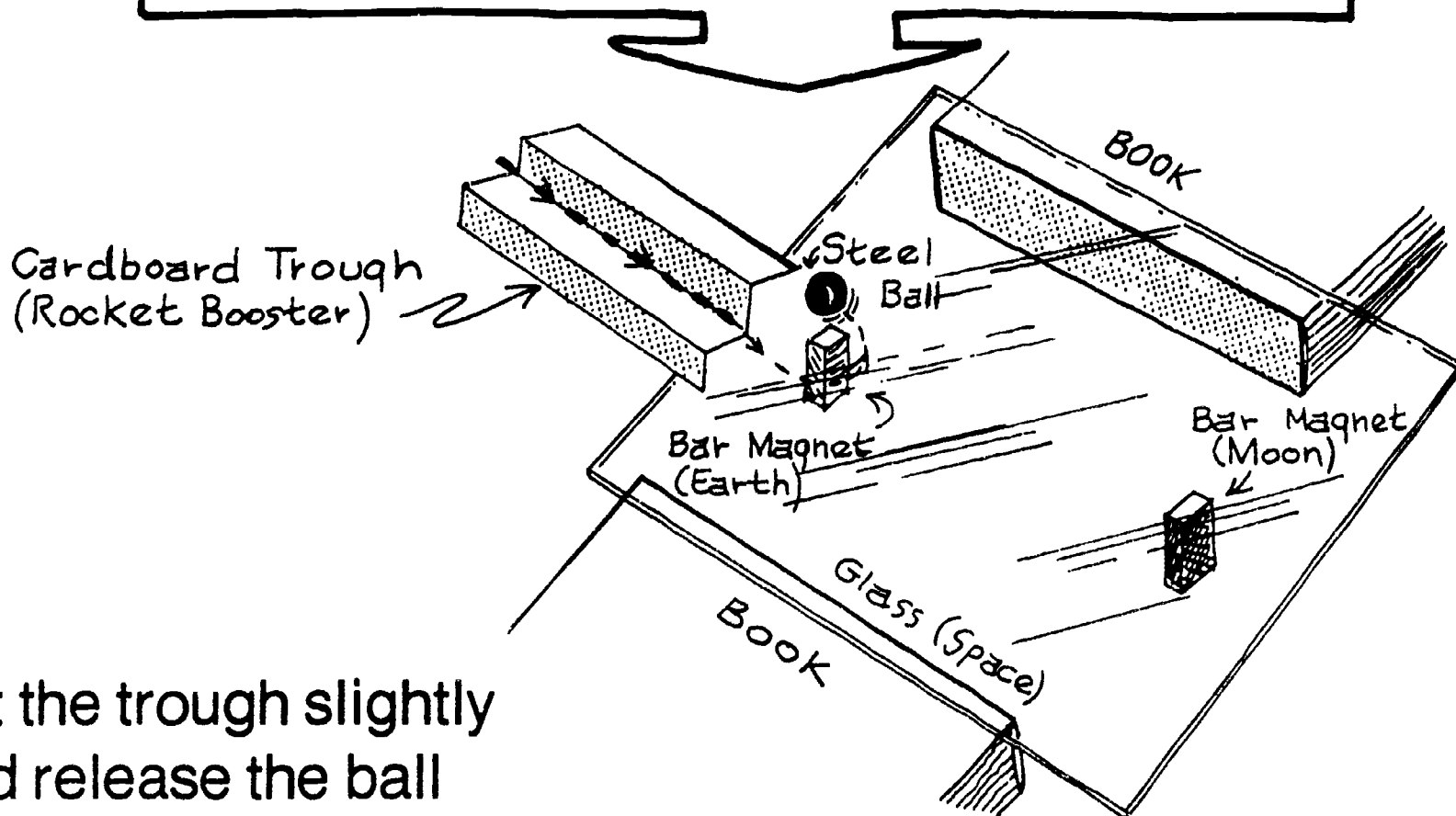

Tilt the trough slightly and release the ball bearing near the end of the trough. What happens? Does the steel ball have enough escape velocity to pull free of the magnet?

To escape Earth's gravitational pull a space vehicle must be boosted to about 25,000 miles per hour. Once free it can coast through space indefinitely.

To increase the speed of the space vehicle (steel ball) increase the tilt of the trough and release the ball near the upper end. What happens as your space vehicle coasts through space (glass pane), and approaches the moon (bar magnet)? How can you change the orbit of your space vehicle?

Increase Tilt
of Trough

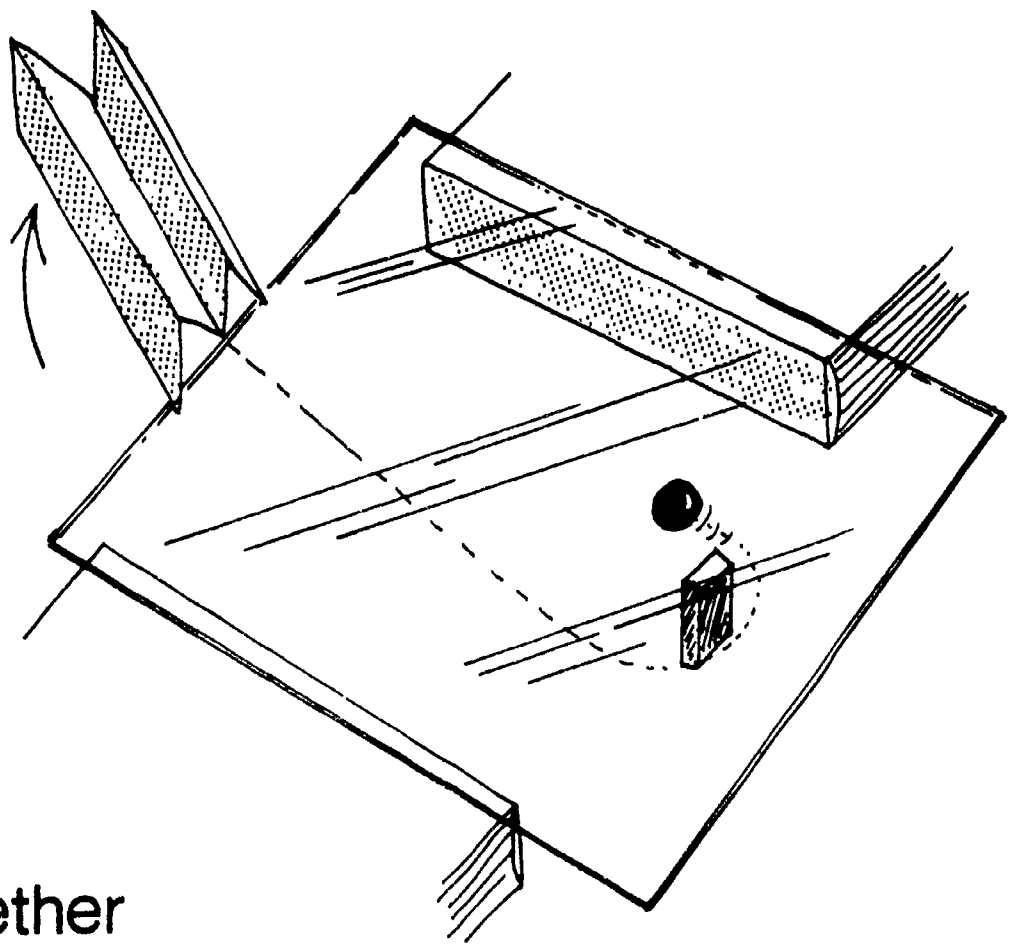

What determines whether your space vehicle will circle, crash into, or race right past the moon?

SPACE CAN MAKE YOUR BLOOD BOIL!

M-1

This activity should be done only with the supervision of the teacher or other designated adult.

Have you ever wondered why pressurized cabins or suits are needed on high flying jets and spaceships? One reason is to supply oxygen to breathe. Another is to prevent water in your tissues – and even your blood – from boiling away! The pressure of the air or other vapor that bear down on a liquid determine its boiling point. At sea level, the boiling point of water is 212 degrees Fahrenheit. In the thin air at about 15,000 feet, water will boil at 98.6 degrees, the temperature of your body. At 63,000 feet, your blood will boil at this same relatively low temperature.

Use an ice cube to boil water!

MATERIALS:

500 ml lab flask (or smaller)
Glass tumbler – Stopper
Tongs or Pot holder
Water – Ice cube
Hot plate

Half fill the flask with water, and boil until steam drives out all the air. Use tongs or pot holder and remove flask from heat. Stopper it tightly! As soon as the visible boiling has stopped,

turn the flask upside down in the tumbler and place an ice cube on the bottom.

As the ice changes the steam back into water — lowering the pressure in the flask — the water will start to boil again and continue boiling until it is barely lukewarm!

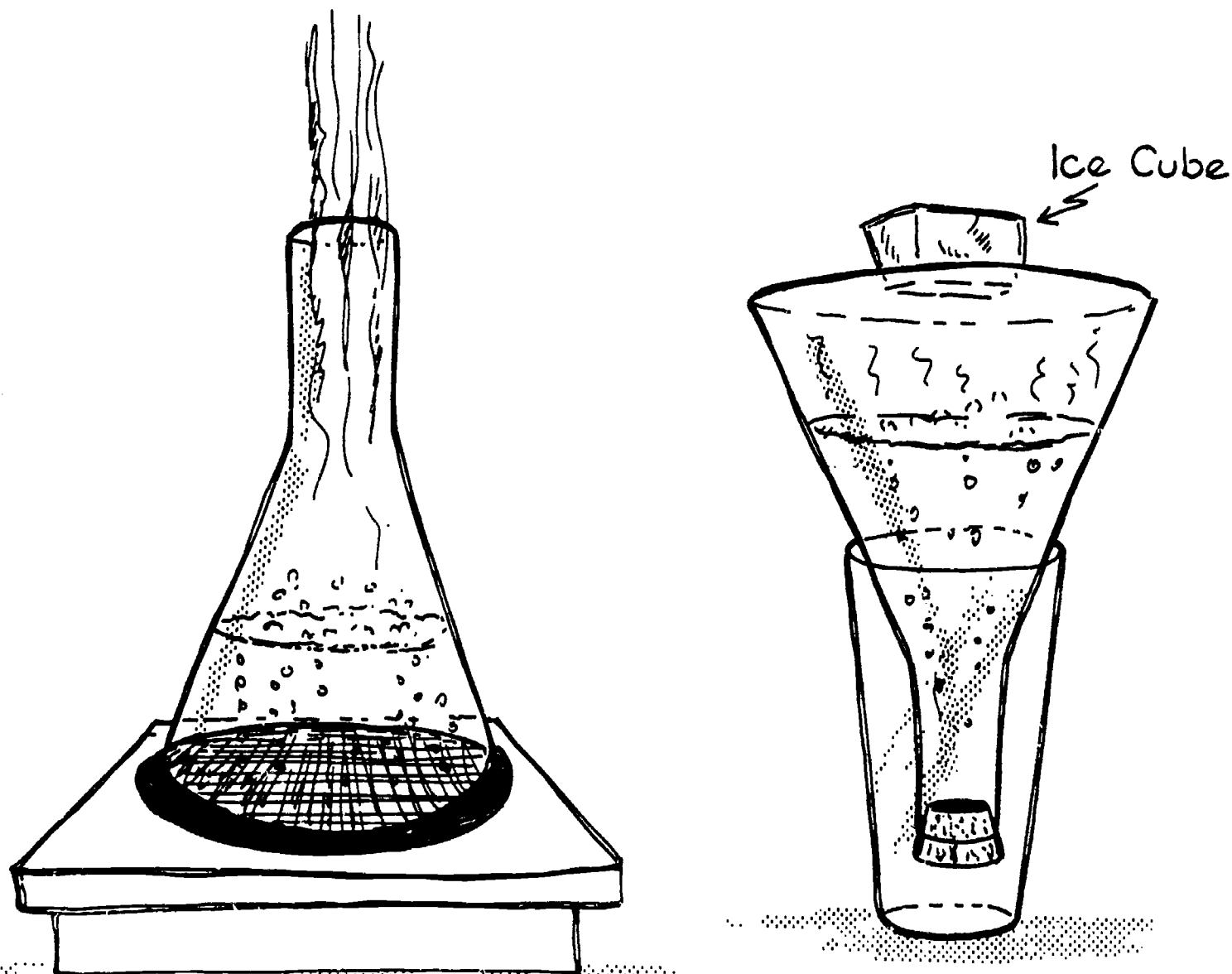

Model building and flying is a way to learn more about aerospace. You might want to make a simple altitude finder to help you find out just how high your model flies.

MATERIALS:

1 straw
 1 protractor
 1 piece cardboard
 8" string
 Washer or weight

Glue or tape protractor to cardboard. Punch a hole near the top at the center of the protractor. Put the string through the hole and knot at the back to secure. Tie a washer to the other end of the string. Tape the straw to the top edge of the protractor.

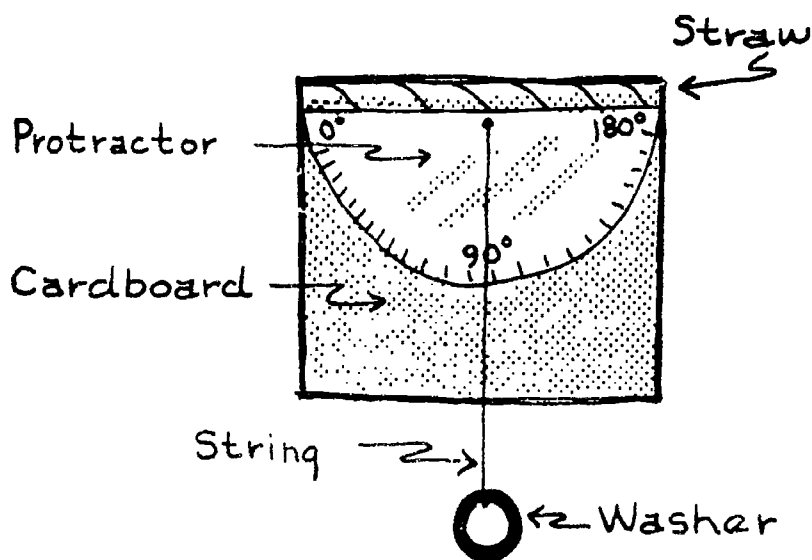

To use the altitude finder, site through the straw and hold the string against the protractor to set the angle. To figure altitude multiply the base times the tangent of the angle.

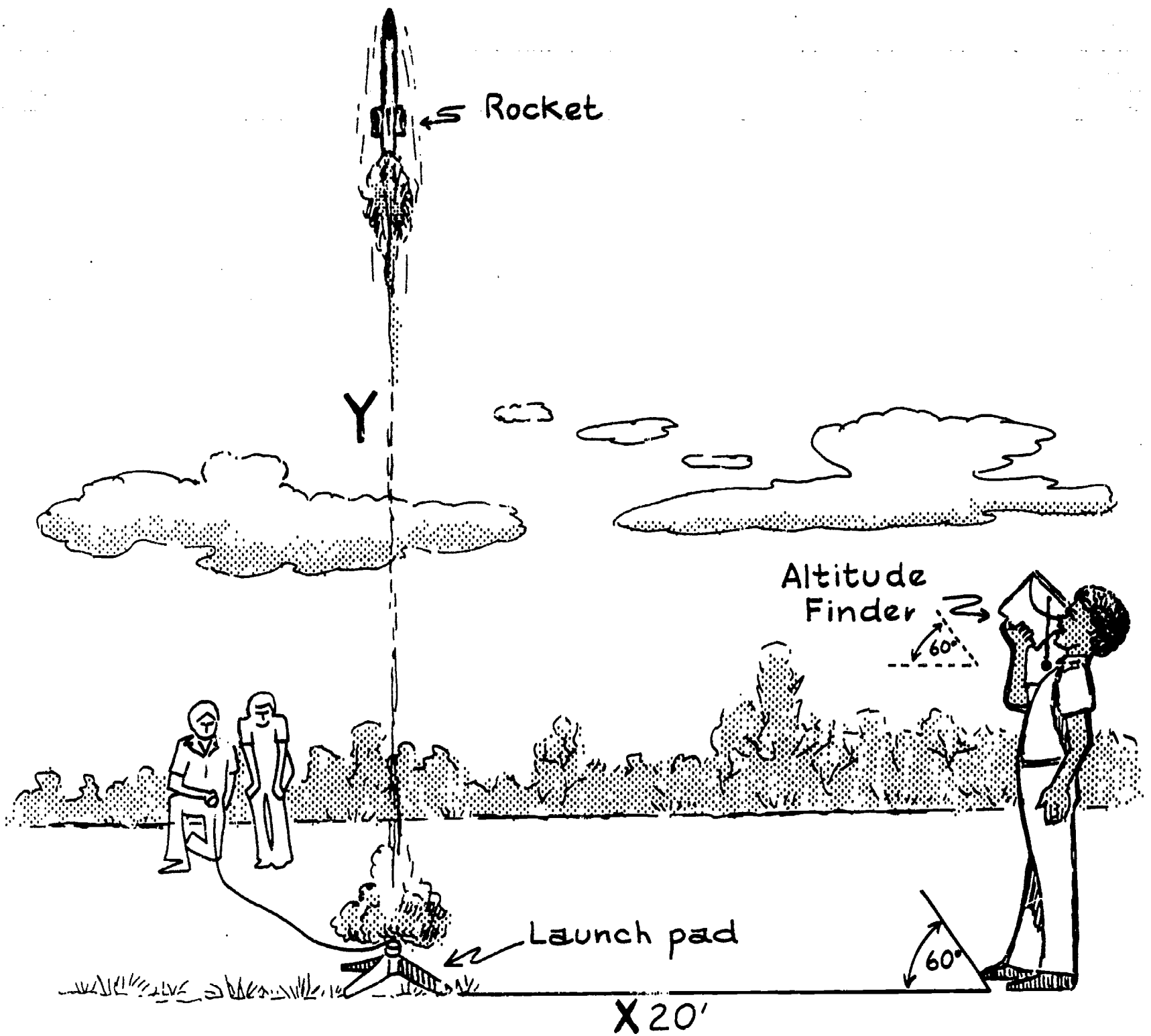

$$\text{Tangent } L = y/x$$

$$y = (x)(\tan L) = (20 \text{ ft}) (\tan 60^\circ)$$

$$y = (20 \text{ ft.}) (1.73)$$

$$y = 34 \text{ ft.}$$

Let's dress ourselves for a space trip. Get a clean gallon milk jug, bleach bottle, or paper bag. Cut a helmet shape and smooth the edges. Decorate with paints, pens, crayons, pipe cleaners, coke tops, straws, paper, fabric or whatever you choose. You can use colored acetate or cellophane for the eye shield.

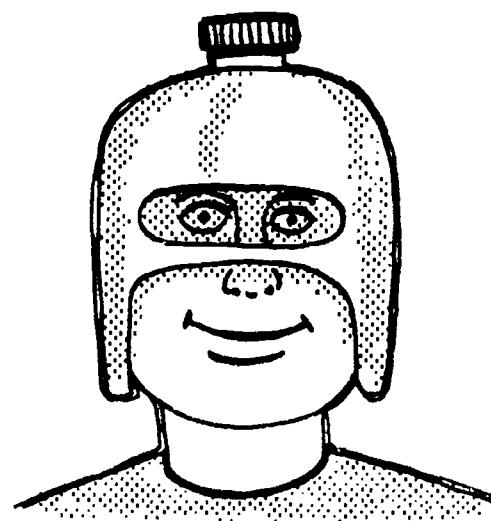
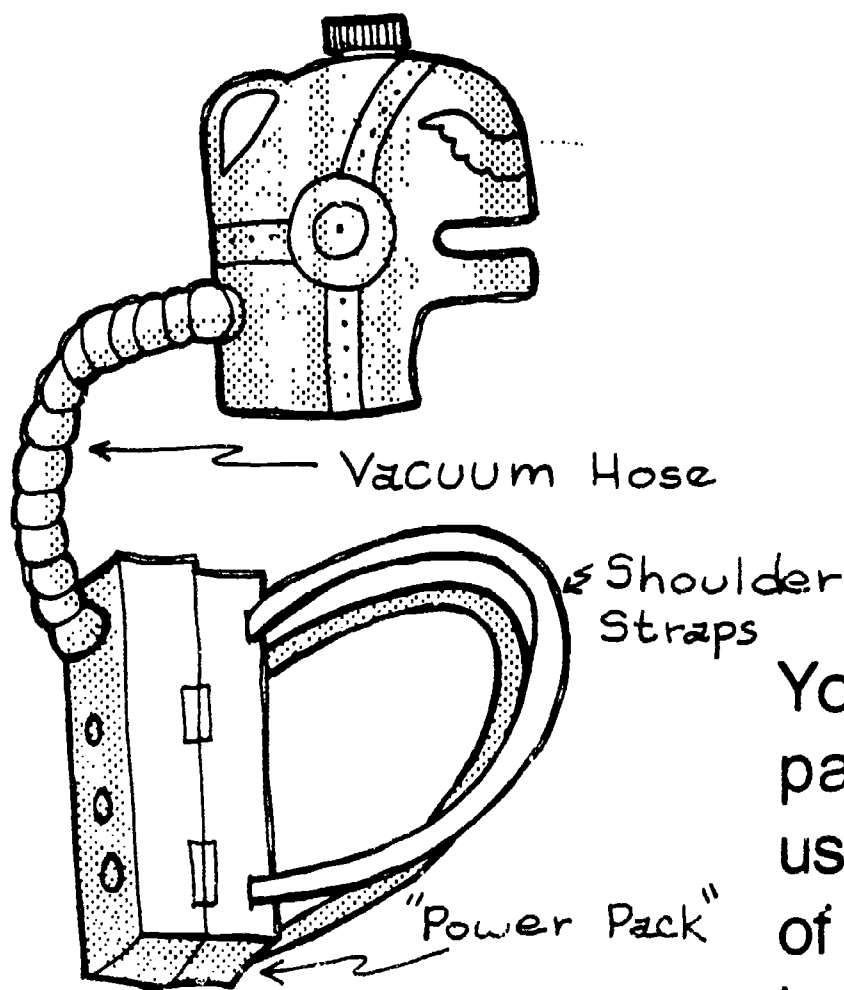
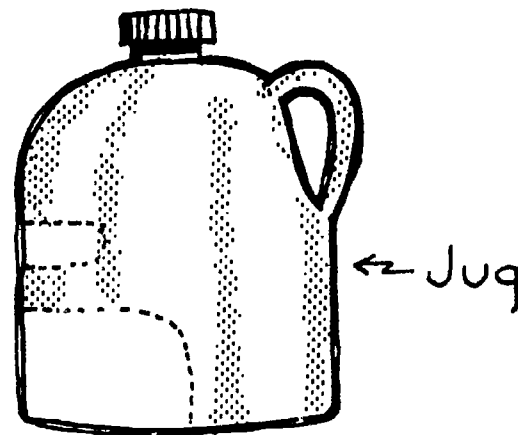

You might want to add a power pack to your space helmet by using a shoebox and a piece of garden, vacuum, or dryer hose. Decorate your power pack with controls and

symbols. Attach some shoulder straps, and countdown for a fulfilled space fantasy.

Hold your finger over the hole, then place the pan on a table or the floor and give it a slight push.

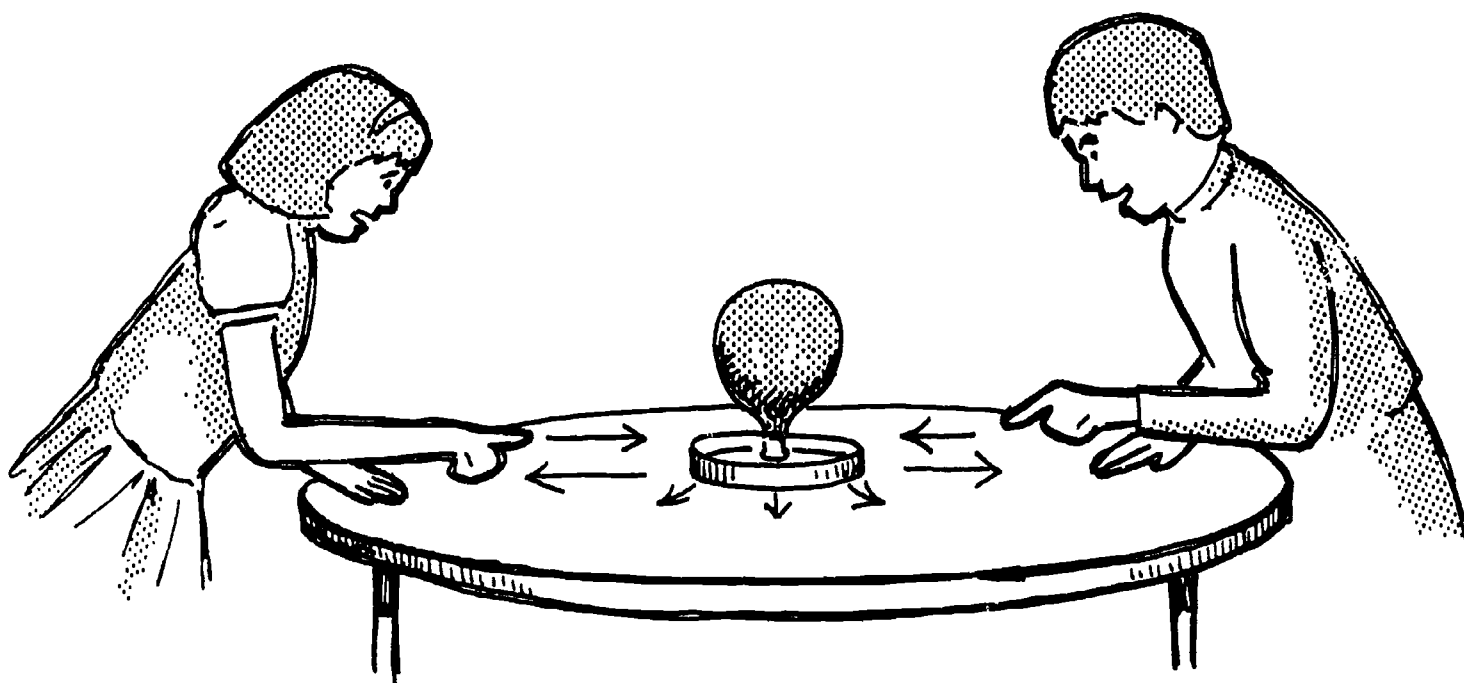

Can you explain what happens? What is the source of power? Can you relate this to the way a rocket works?

Design some experiments to see how far your craft will go, how fast it will go, and how much weight it can carry.

Vehicles that skim over rough seas and rugged terrain on a cushion of air are called hovercraft, hydroskimmers, or ground-effects machines (GEM). You can build a model that will show how these almost friction-free air supported vehicles work.

MATERIALS:

A metal pie pan with
a smooth bottom

A spool

Glue

A balloon

Turn the pan over and punch a small hole in the center. Glue the spool to the inside of the pan, centering it over the hole. Stretch the neck of the balloon well down over the spool. Inflate the balloon by blowing through the hole in the bottom of the pan.

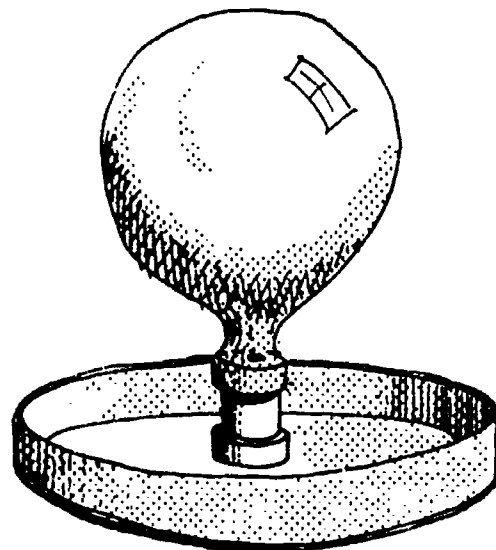

SPACE EXPLORATION

- NL-1 NEWTON, THE FATHER OF EQUALITY OF FORCES
- NL-2 NEWTON'S LAW - EQUALITY OF FORCES
- NL-3 NEWTON IS RIGHT AGAIN!
- NL-4 HAS NEWTON LOST HIS MARBLES?
- NL-5 WHAT IS INERTIA?
- NL-6 IS THE HAND REALLY QUICKER THAN THE EYE?
- R-1 WHY ARE ROCKETS SHAPED THE WAY THEY ARE?
- R-2 HOW DO ROCKETS WORK?
- R-3 WHY DO ROCKETS FLY?
- R-4 TEST TUBE TAKEOFF!
- R-5 POP GOES THE ROCKET!
- G-1 THE FORCE!
- G-2 CAN GRAVITY BE SLOWED DOWN?
- G-3 WEIGHT A MINUTE!
- G-4 MAN MADE GRAVITY
- S-1 LAUNCH A MARBLE SATELLITE!
- S-2 WHY DO SATELLITES STAY IN ORBIT?
- S-3 SPINNING SATELLITE!
- S-4 THE GREAT ESCAPE!
- M-1 SPACE CAN MAKE YOUR BLOOD BOIL!
- M-2 SKY HIGH!
- M-3 SPACED OUT!
- M-4 A REAL GEM!

BIBLIOGRAPHY

May, Julian. *Rockets*. Chicago: Follett Publishing Company, 1977.

Gottlieb, William P. *Jets and Rockets and How They Work*. New York: Doubleday & Company, 1959.

Taylor, John W.R. *Rockets and Missiles*. New York: Grosset & Dunlap, 1970.

Herbert, Don and Ruchks, Hy. *Mr. Wizzard's 400 Experiments in Science*. New York: Book-Lab, Inc., 1968.

Stone, A. Harris and Siegel, Bertram M. *Take A Balloon*. Englewood Cliffs: Prentice-Hall, Inc., 1971.

Milgram, Harry. *First Experiments with Gravity*. New York: E. P. Dutton & Co., 1966.

Swezey, Kennetta M. *Science Shows You How*. New York: McGraw-Hill, Inc., 1964.



DEPARTMENT OF TRANSPORTATION
FEDERAL AVIATION ADMINISTRATION

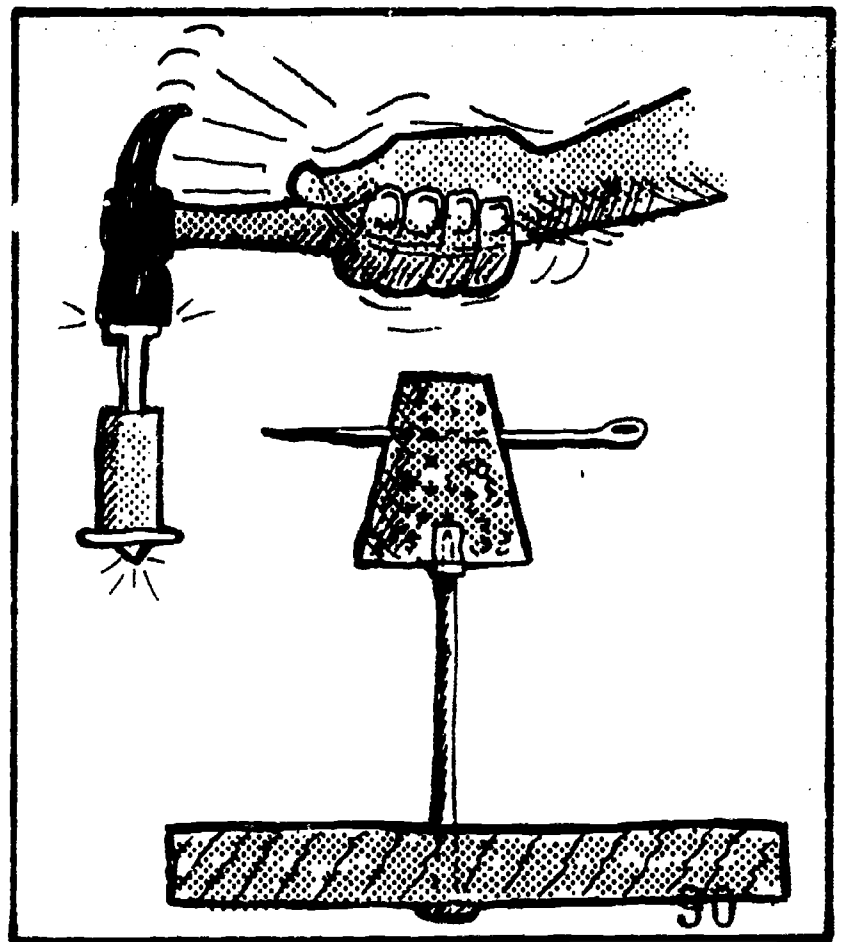
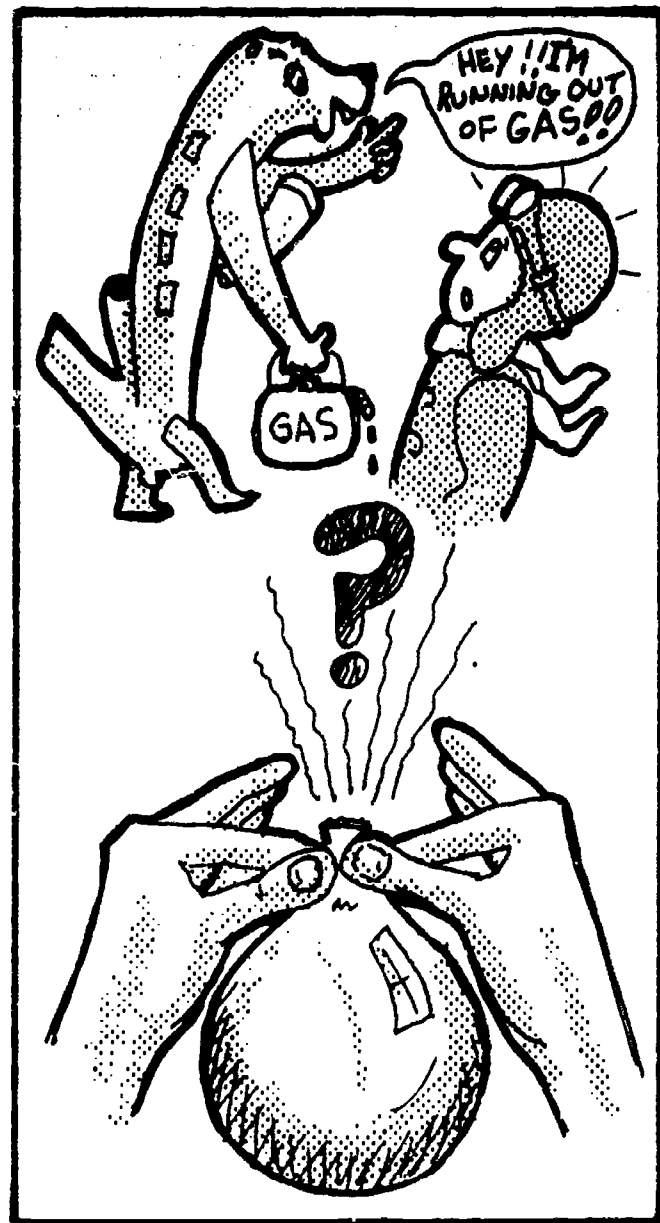



TEACHER'S INFORMATION

Demonstration Aids for Aviation Education— Volume II is a series of simple, concrete, revealing experiments developed by the Civil Air Patrol Center for Aerospace Education Development for the Federal Aviation Administration specifically for upper elementary grades. These activities can be adapted to meet the needs of varied teaching situations and different grade levels.

These materials are primarily designed as pupil directed experiences. In some instances the teacher may want to further extend the investigations. This series is intended to be a springboard for your own ideas to demonstrate concepts of the Air Age to your students. Young children can learn scientific principles through simple learning activities; older students can benefit from a review using the same activities.

The purpose of this series is to illustrate certain principles related to various concepts of aviation and space. More important, it is an opportunity for you to directly involve students in investigations and in making discoveries on their own.

You needn't be an "expert" in science to use this material. In fact, you shouldn't be expected to have all the correct answers to the questions presented in the material. Moreover, many of the activities are designed to include interdisciplinary skills and need not be used in sequence.

Each packet in the series forms a coherent program of instruction on a single topic: Non-powered Flight, Aerospace and the Environment, Space Exploration and Communications. Most of the tasks are introduced as a question. In order to answer the question, the students may want to first predict the solution. Then have them follow the activity instructions to arrive at an answer. This kind of student involvement may lead to other related questions generated by the teacher, other students, or suggested on the cards themselves.

Most of the activities utilize materials readily available from any given community and can be completed in the classroom. Others may require that you borrow some equipment from your science resource center or from a junior or senior high school in your district.

Please let us know your reactions to the materials and feel free to ask for more information related to aviation or space. We wish you success and many enjoyable experiences as you use these packets.

Written by Ms Debbie Williams and Ms Carol Hickson
Editorial Assistance by Mrs. Patricia Smithson
Illustrated by Mr. Harley A. Samford

Communication is sharing information. People communicate. Animals communicate. Even machines communicate.

Communication consists of three elements: A sender, a receiver, and a language. When a message goes to a receiver, symbols are being transmitted, not ideas.

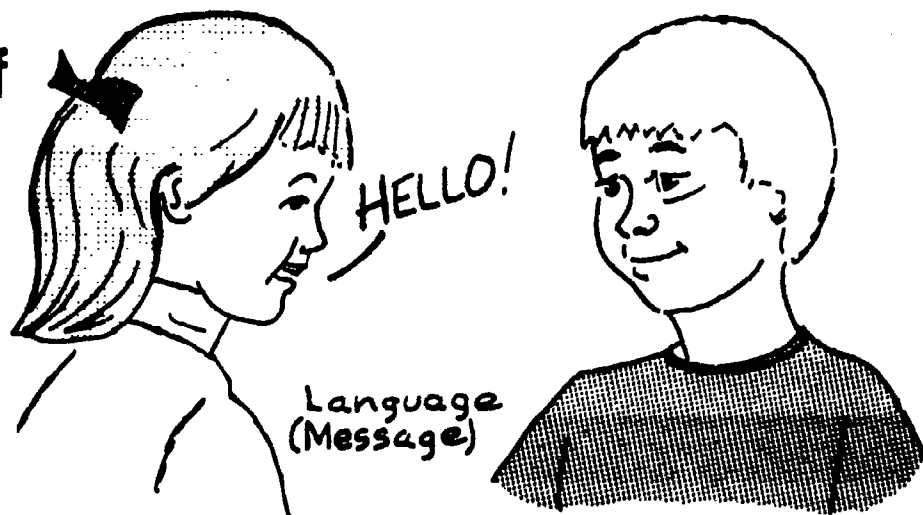

When the symbols mean the same to the sender and the receiver, communication takes place.

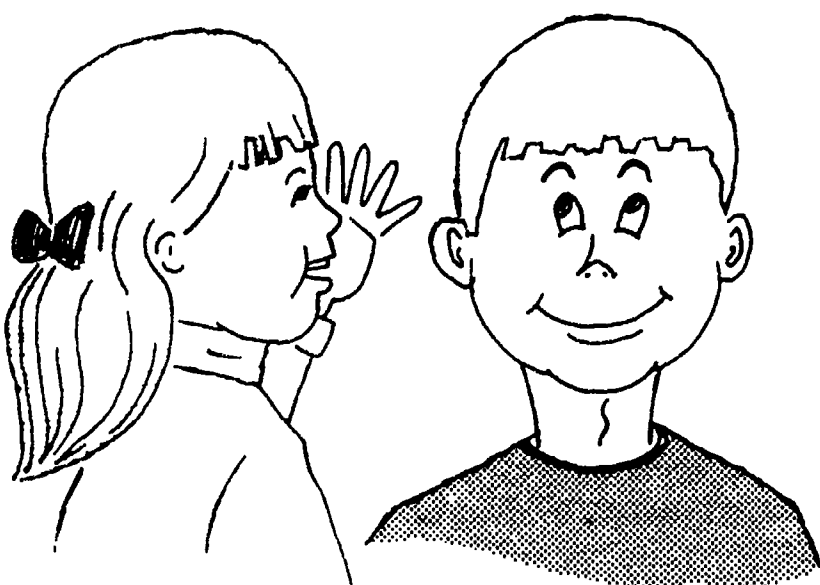

TRY THIS GOSSIP GAME:
Have one person start a short phrase to be whispered from person to person. Have the last person receiving the message repeat it aloud. Compare the message with the original phrase. Did communication take place? Did everyone communicate?

Information is a message which communicates knowledge to us. All information is transmitted as symbols such as written words, pictures, dots & dashes, or sounds.

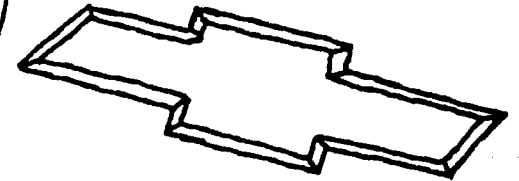
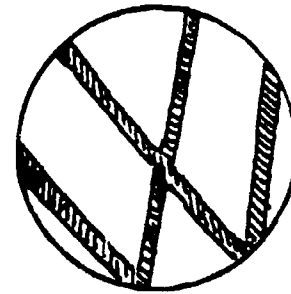

BRAG

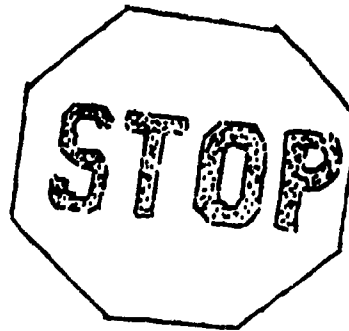

Hurricane

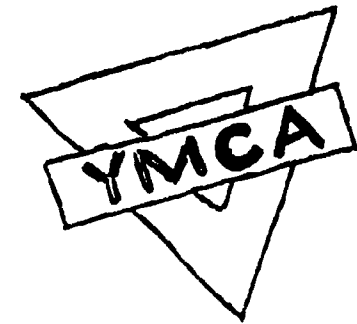

The sets of symbols used to send information is called a code. We receive hundreds of coded messages every day. A special form of code is called a cipher. A cipher involves replacing letters in a message with other letters and is the form of coding most often used in intelligence work. For example:

A=Z	K=P	U=F
B=Y	L=O	V=E
C=X	M=N	W=D
D=W	N=M	X=C
E=V	O=L	Y=B
F=U	P=K	Z=A
G=T	Q=J	
H=S	R=I	
I=R	S=H	
J=Q	T=G	



Decode the following message:

XRKSVI Z HVXIVG
 NVHHZTV ULI Z
 HKVXRZO UIRVMW.

When things vibrate they make sound waves.

MATERIALS:
Pocket comb
Cellophane or
Kitchen plastic wrap

Put the cellophane or kitchen wrap around a clean pocket comb. Place the comb between your lips. Blow on the comb like a harmonica. What happens?

Now, blow and hum, like on a kazoo. What happens? Can you play a tune on your "musical comb"?

Why does the sound tickle your lips?



Sounds differ in many ways. The high or low of a sound is called pitch. The faster things vibrate, the higher the sound, the slower things vibrate, the lower the sound.

Try blowing up a balloon and letting the air out slowly by stretching the opening of the balloon. What happens? How can you change the sound as the air leaves the balloon?

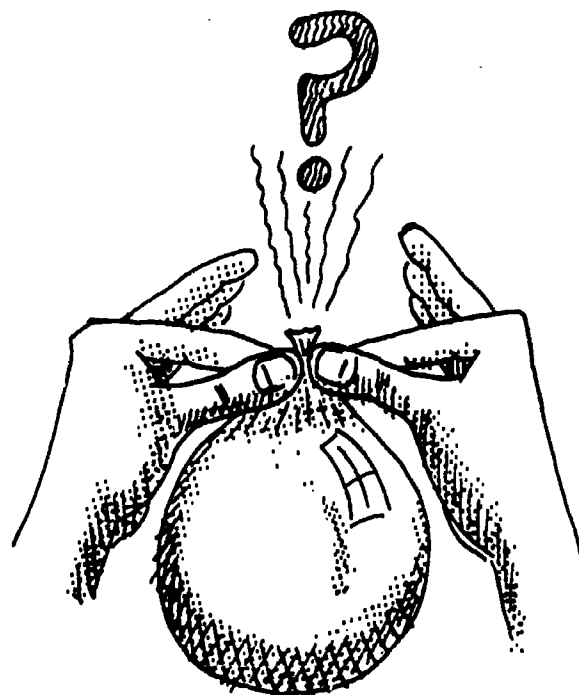

Use this same idea to make a singing stick. You might use a ruler, paint stirrer, or thin piece of wood. Make a hole in one end and tie a piece of string to the stick. Make sure there is space around you and swing the stick overhead in a circle.

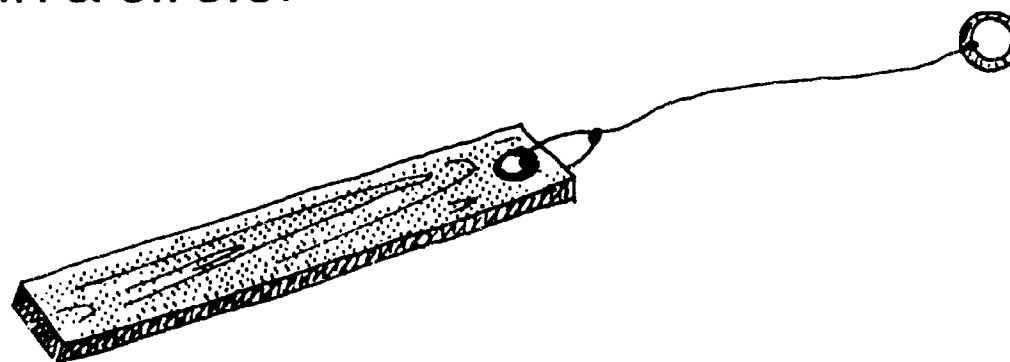

What happens when you swing the stick harder?
Why?

Can you think of other ways to produce different sounds? Can you think of ways to reduce sound in our environment?

MATERIALS:

Empty tin can
Cardboard
Lamp or flashlight
Balloon – Glue
Rubber band
Small piece of mirror

Use a can opener and remove both ends from a clean tin can. Cut the neck off a balloon and stretch the remaining part tightly over one end of the can and hold it in place with a rubber band. Glue the piece of

mirror onto the stretched balloon about a third of the way in from the edge of the can.

Shine the light source on the mirror at an angle, and place the cardboard so that it catches the reflection as a spot of light. What happens if you sing or shout into the open end of the tin can. Can you see sound? Can you cause the vibrations to speed up or slow down?

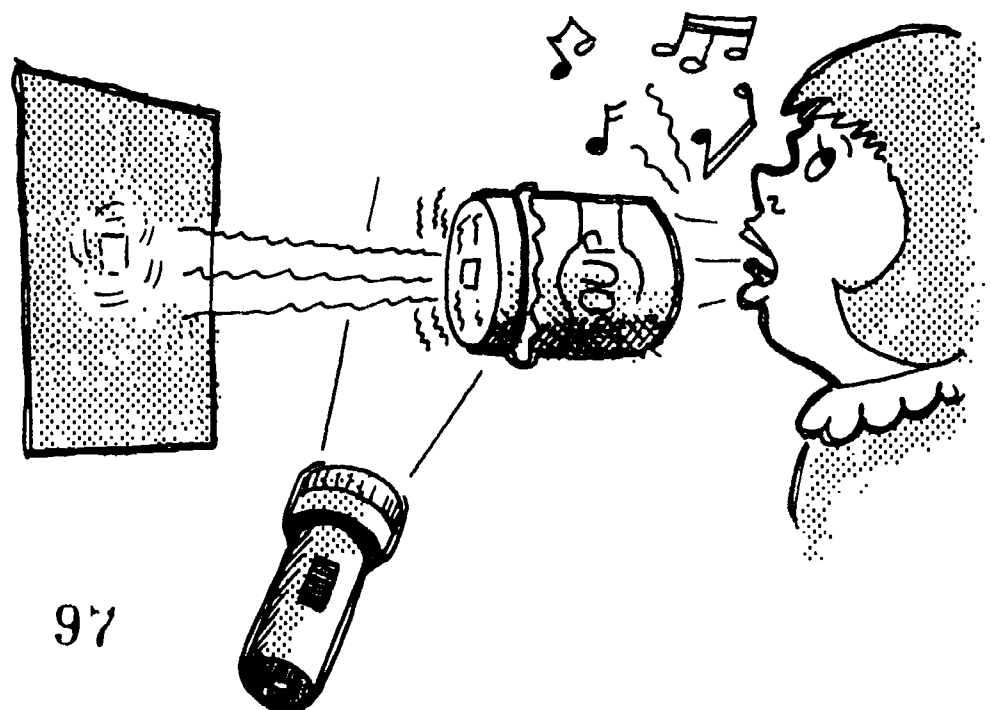

You can see that sound is made of vibrations. As your voice travels through the air, the vibrations are passed along air particles to the stretched balloon, causing the mirror to wiggle.

The diaphragm in a telephone receiver changes the sound of your voice into electrical signals just as the stretched balloon and mirror change sound into moving light.

Make a simple communications system with the following materials:

MATERIALS:

2 cans (juice, coke, soup, etc.)

16' piece string or wire

Cut one end out of the can, punch a small hole in the middle of the other end of the can. Push the string

through the holes and knot to secure.

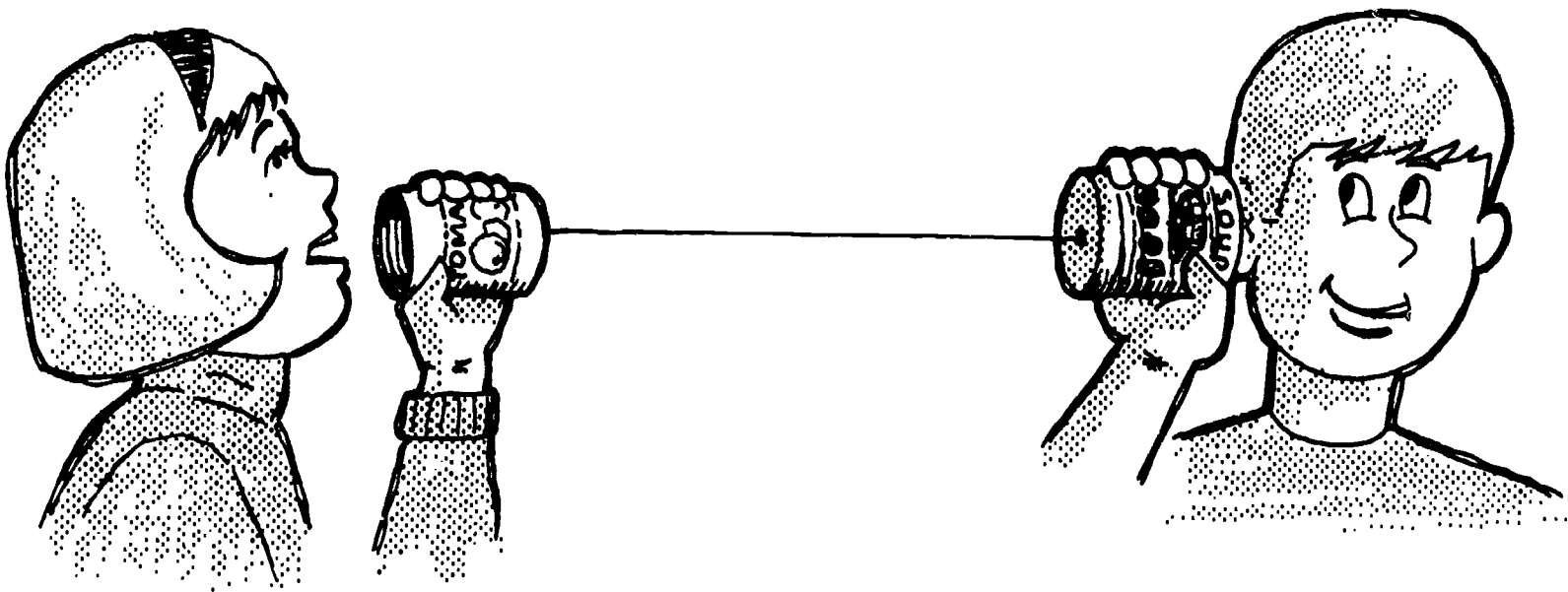

Stretch the string out its full distance, talk into the open end of the can, and listen at the open end of the can. What are the five elements of communication in this system?

1. Source _____
2. Transmitter _____
3. Channel _____
4. Receiver _____
5. Destination _____

voice, can, string, can, ear

HOW DO AIRPLANES COMMUNICATE WITH THE PILOT?

SENDER + RECEIVER + LANGUAGE = COMMUNICATION

It may seem strange to think of an airplane communicating with a pilot. But remember, for communication you only need three things — A sender (the airplane), a receiver (the pilot) and a language (the aircraft's instruments).

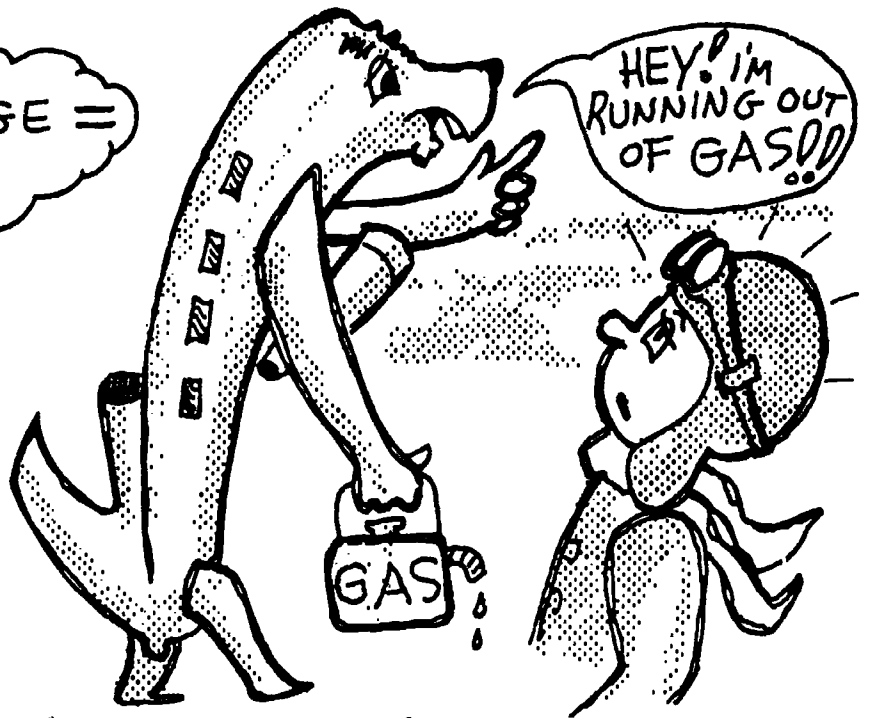

Pilots use instruments to tell him important things about airplanes. They tell if the plane is climbing, the speed, altitude, direction, etc.

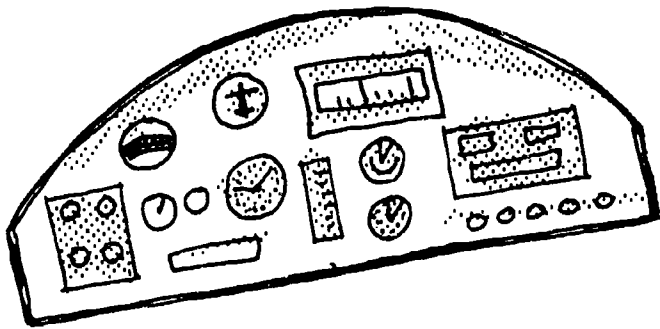

Airplane instruments are displayed on a panel and most of them measure by a push or a pull. The force may be very small and must be large enough to be seen. This is done with a lever called linkage.

MATERIALS:
Soda Straw
Straight Pin
Cardboard
Ruler

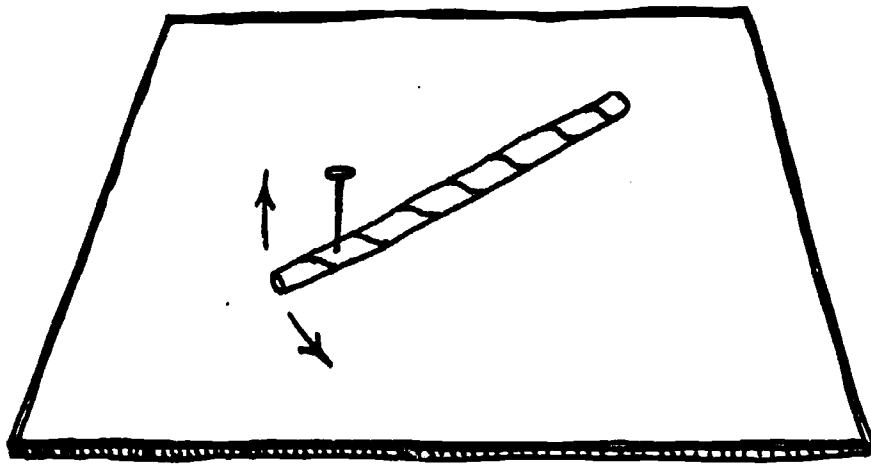

Put the pin through the straw 1 inch from one end. Insert the pin in the cardboard. Mark the position of both ends. Move the short end a distance of one inch.

Measure how far the long end moved.

Navigation is very important to a pilot. During a flight, a pilot can use landmarks on his map and locate them on the ground as he sees them. At night or when it is cloudy, the pilot must rely on his compass at all times.

Let's make a simple compass.

MATERIALS:

Magnet
Sewing needle
2 small corks
Glass container
Water

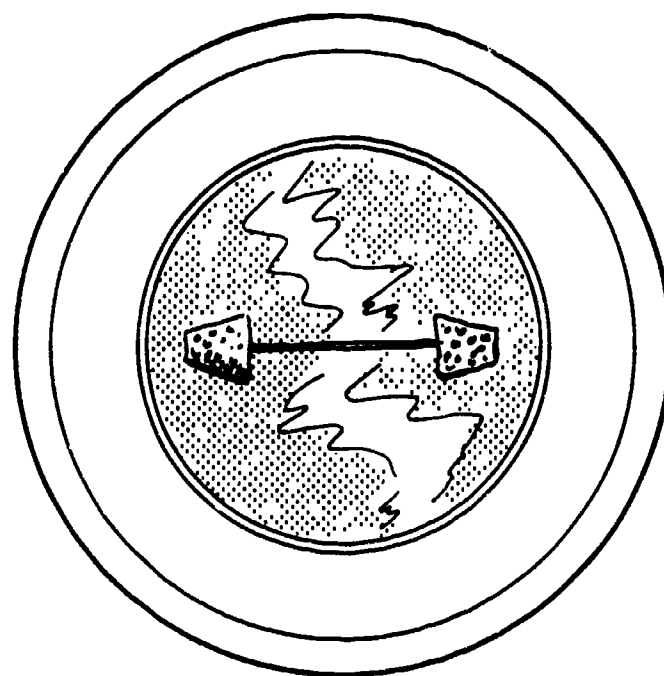

Since a compass is a magnet mounted on a pivot, you will first need to magnetize the needle. This is done by stroking the needle from the center outward in the same direction several times. Then reverse the magnet and the needle and stroke again from the center outward.

* Be sure the container is away from any metal! The needle will line up with the North and South magnetic poles.

An airplane compass is more complex than the floating compass. To make a compass that can move freely, follow these directions.

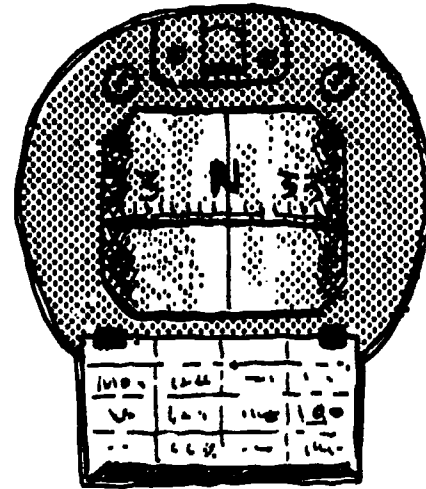

Airplane Compass

MATERIALS:

- Wooden block
- Finishing nail
- Hammer
- Cork
- .22 shell case
- Needle (magnetized)

Hammer a point in the end of the shell case with a nail. Then drive the nail through the center of the wooden block.

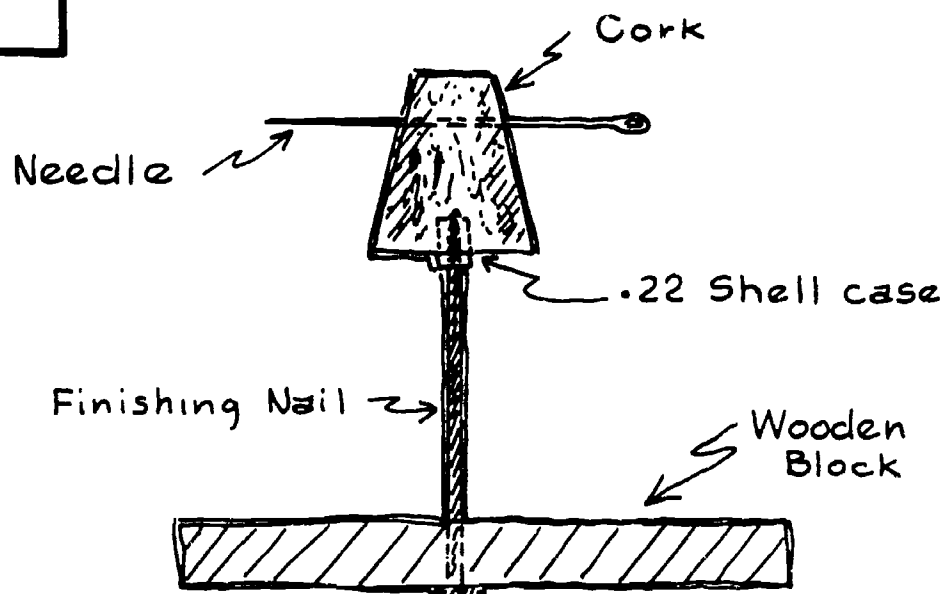
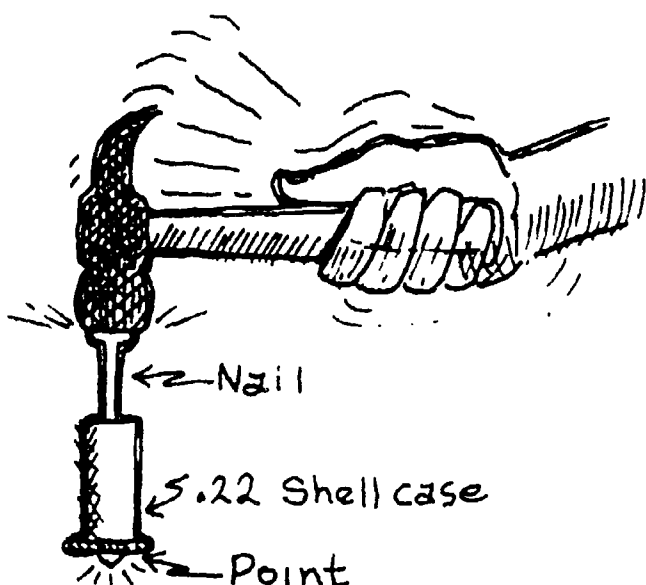

Put the magnetized needle through the cork. Wrap a band of paper around the top of the cork.

When the needle is balanced, parallel to the board, it will align with the North and South magnetic poles. Mark the major compass points, (N, S, E, W) on the paper band. As you move around your compass, the direction you are facing will be on the band. The compass always points north. As you move around it, you change your direction, just as an airplane changes its direction around the compass.

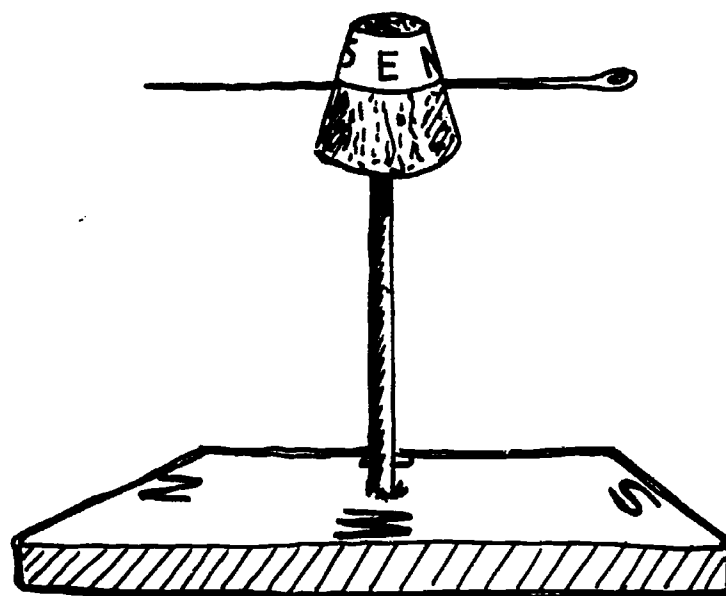

A pilot or navigator uses special instruments to help him find and maintain his position in relation to the magnetic poles. You can make a compass and use it to do the same thing.

You can make another simple instrument to help you determine the direction of the magnetic lines of force for any place on Earth. It is called a Dipping Needle.

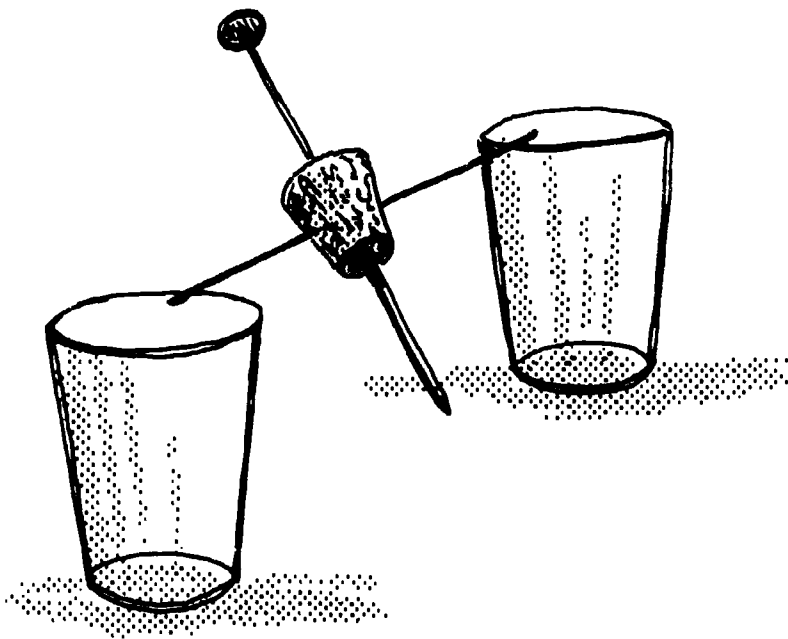

MATERIALS:

Steel knitting needle
or wire
2 sewing needles
(unmagnetized)
2 water glasses
A cork

Magnetize the knitting needle by stroking it 20-30 times with a strong magnet. Run the knitting needle through the center of the cork. Press the unmagnetized sewing needles into the sides of the cork. Place the glasses in an east-west position. Balance the sewing needles on the rims of the glasses so that the magnetic knitting needle is in a

north-south direction. The magnet should dip in line with the lines of force of Earth's magnetic field.

Try moving various objects near your Dipping Needle and see how the needle reacts.

We seem closer to other parts of our world because today we have instant information. We live in a world full of information machines. Radio, TV, teletypes, telephones, and satellites speed

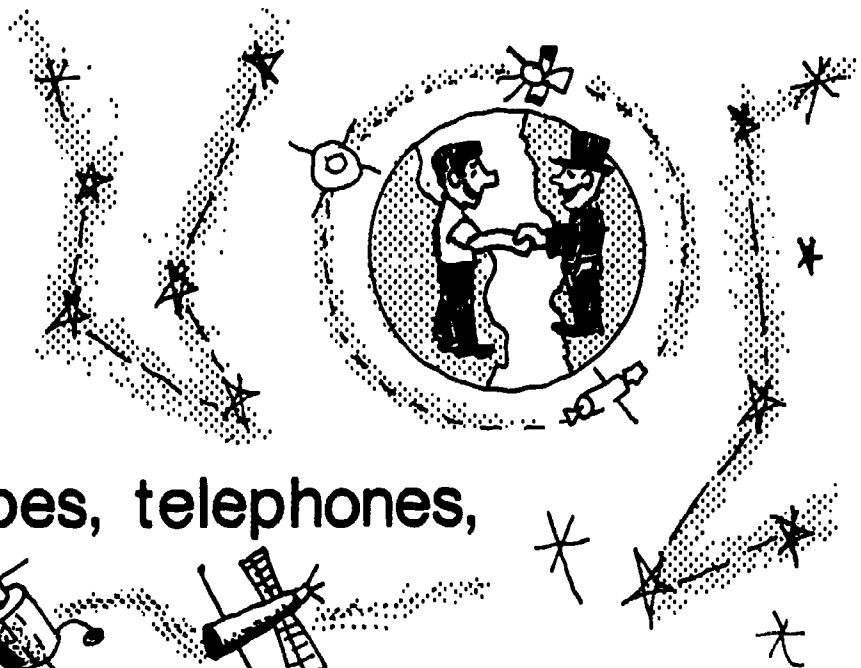

messages around the world. Satellites in space communicate with man on earth by electronic means. Weather satellites take pictures which are scanned by a beam of light and changed into a radio signal. The radio signal is then sent to Earth and converted back into a picture.

Can you draw a picture with signals?

MATERIALS:
Pencil, Graph paper

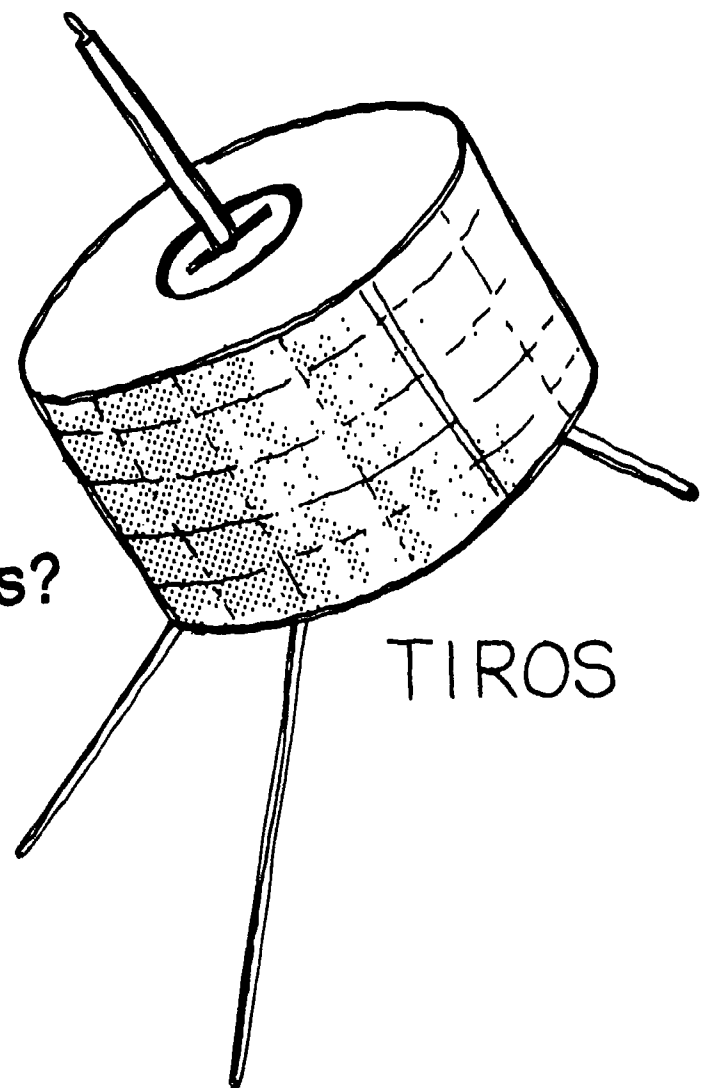

Find your starting point 5 squares down and 7 squares from the left.

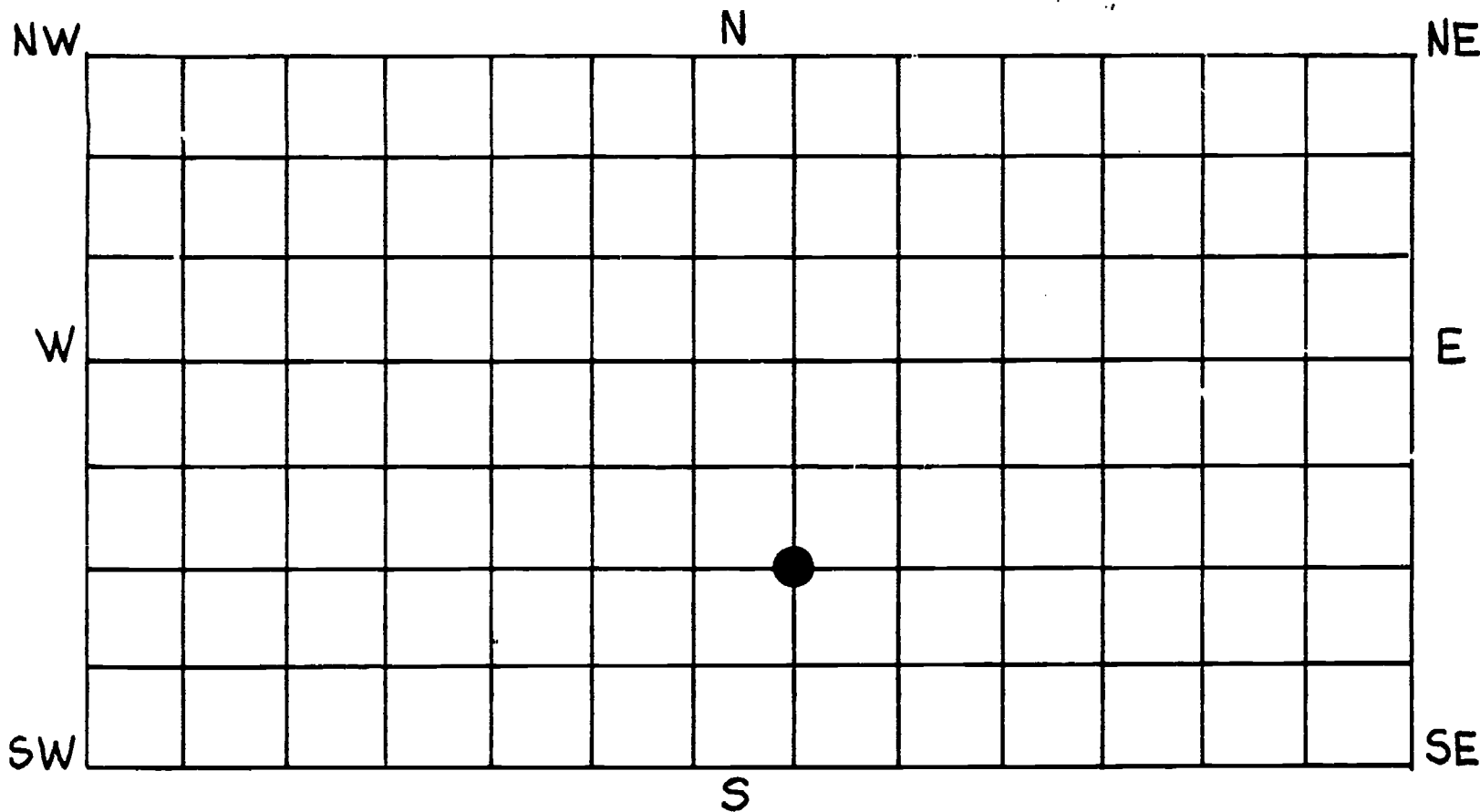

Move your pencil in the direction and the number of squares indicated.

3 W, 1 NW, 2 E, 3 N, 2 SE,

2 W, 1 S, 3 E, 1 SW.

Make up your own picture. Call the signals to a friend.

When a spacecraft takes a picture in space, that picture is changed into a radio signal and sent back to Earth. Here on Earth the signals are changed back into a picture. Let's try doing this using one student as the satellite, another student as the receiving station on Earth and a two number code as the radio signal.

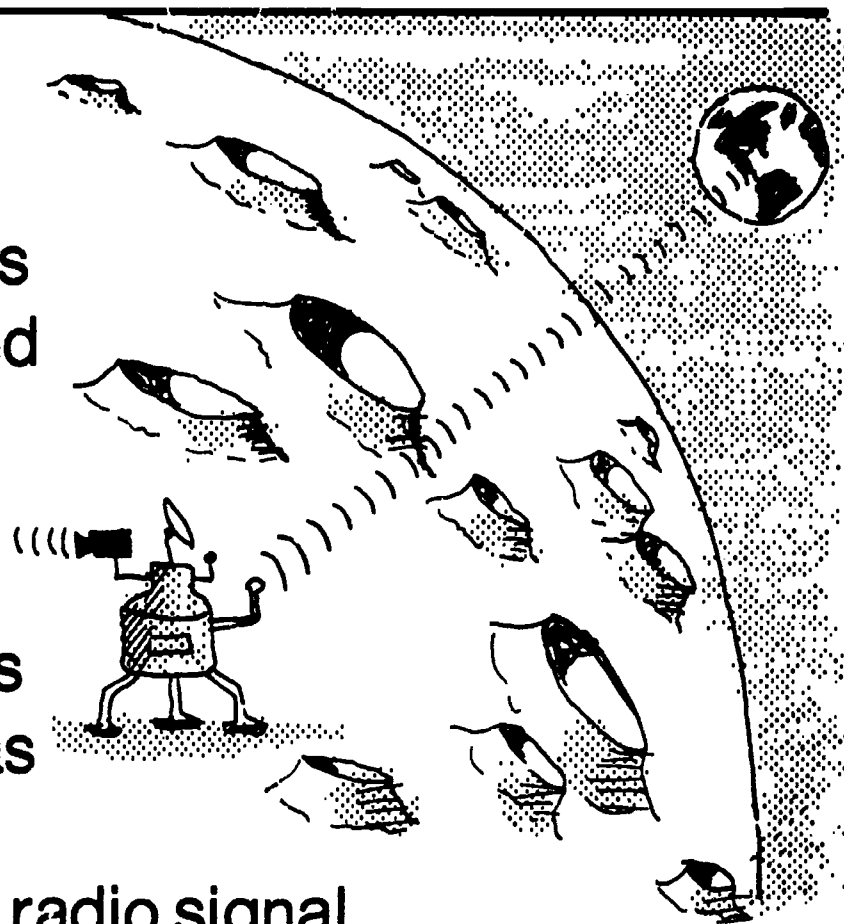

MATERIALS:

2 sheets of graph paper, 2 pencils.

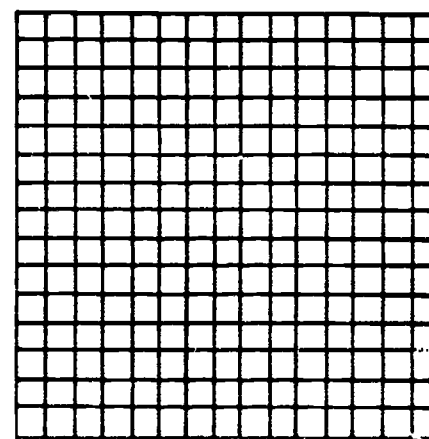

Each picture will be drawn on a block of graph paper 15 squares by 15 squares. Mark off 15 x 15 squares on both pieces of graph paper.

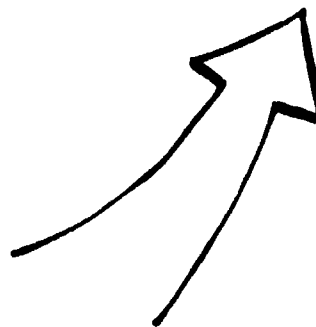

The student who is the satellite should draw a picture on his/her piece of graph paper by filling in some of the squares. The satellite scans the picture beginning in the first square

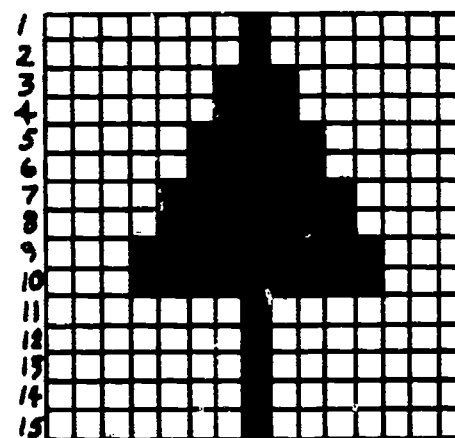

(left) in row #1 and proceeding square by square across the row to the last square in row #1. The scan then moves to the first square (left) in row #2 and scans across that row, etc. As each row is scanned, if the square is empty the satellite says "Zero". If the square is filled in, the satellite says "one". The ground receiving station follows the scan on his/her piece of graph paper and every time he hears the word "one" he fills in that square. At the end of row 15 compare the two pictures. Did you communicate?

Try this picture

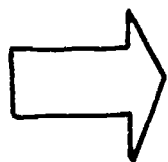

Row	CODE														
1	0	0	0	0	0	0	0	0	1	1	1	0	0	0	0
2	0	0	0	0	0	0	0	1	0	1	0	1	0	0	0
3	0	0	0	0	0	0	0	1	1	1	1	1	0	0	0
4	0	0	0	0	0	1	0	0	1	1	1	0	0	0	0
5	0	0	0	0	0	1	0	0	0	1	0	0	0	0	0
6	0	0	0	0	0	1	0	0	0	1	0	0	0	0	0
7	0	0	0	0	0	1	1	1	1	1	1	1	1	1	0
8	0	0	0	0	0	0	0	0	1	1	1	0	0	1	0
9	0	0	0	0	0	0	0	0	1	1	1	0	0	1	0
10	0	0	0	0	0	0	0	0	1	1	1	0	0	1	0
11	0	0	0	0	0	0	0	0	1	1	1	0	0	0	0
12	0	0	0	0	0	0	0	0	1	0	1	0	0	0	0
13	0	0	0	0	0	0	0	1	1	0	1	1	0	0	0
14	0	0	0	0	0	0	1	1	0	0	0	1	1	0	0
15	0	0	0	0	0	1	1	0	0	0	0	0	1	1	0

AEROSPACE COMMUNICATION

- AC-1 WHAT IS COMMUNICATION?
- AC-2 HOW DO WE COMMUNICATE?
- AC-3 SOUND OFF!
- AC-4 LET'S HEAR IT FOR PITCH!
- AC-5 VISIBLE VIBRATIONS
- AC-6 HELLO!
- AC-7 HOW DO AIRPLANES COMMUNICATE WITH THE PILOT?
- AC-8 WHERE AM I GOING?
- AC-9 FOLLOW THAT COURSE
- AC-10 WHICH WAY?
- AC-11 IS OUR WORLD SHRINKING?
- AC-12 GET THE MESSAGE?

BIBLIOGRAPHY

Asimov, Isaac. *Satellites in Outer Space*. New York: Random House, 1966.

Meadows, Charles T. *Sounds and Signals*. Philadelphia: The Westminister Press, 1975.

- Meadows, Charles T. *Sounds and Signals: How We Communicate*. Philadelphia: The Westminister Press, 1975.

Neal, Charles D. *Sound*. Chicago: Follett Publishing Company, 1962.

Stone, George K. *More Science Projects You Can Do*. Englewood Cliffs: Prentice-Hall, Inc., 1970.